

FD10/15/18(T)-MGI1~2

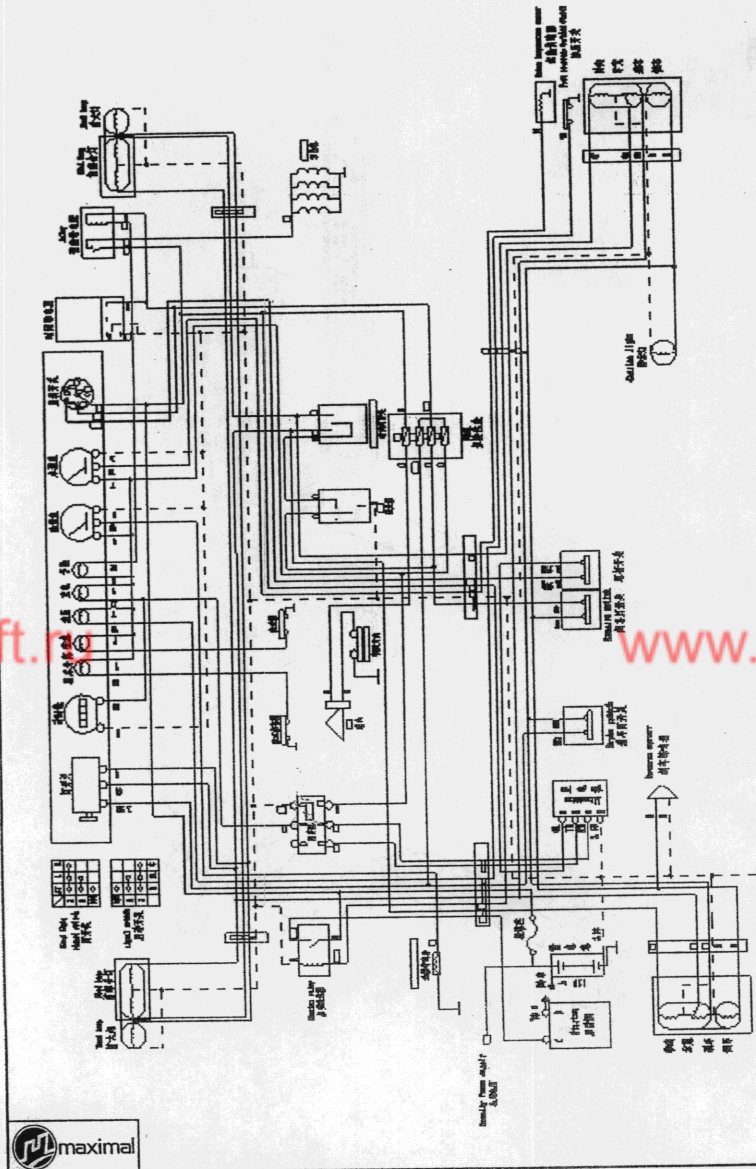

序号 Item No	图号 Part No	零部件名称 Description	件数 Q'ty	备注 Remark
1	BL84-107	Head lamp ass'y	前大灯	2 12V
2	Z-QX 85X85	Front combination lamp ass'y	前组合灯	2 12V
3	Z-HXF 220X55	Rear combination lamp ass'y	后组合灯	2 12V
4	6-QW-90	Battery	蓄电池	1
5	M3032401000	Wiring harness	主线束	1
6	HZB908E-MKS	Combination	组合仪表	1 全英文显示
7	HZB908W5-MKS	Combination	组合仪表	1 中英文显示
8	CYPC-012	Combination	组合仪表	1 选配
9	DL125G	Horn	喇叭	1
10	SGQ-154	Flasher Unit	闪光器	1
11	JK808	Switch, turn signal	转向灯开关	1
12	JK411	Key switch	启动开关	1
13	JK211	Lamp switch	灯开关	1
14	WG424(R1/2)	Oil warning switch	油温报警器	1
15	-	Electric box	电气盒	1
16	DJB-12B	Back buzzer	倒车蜂鸣器	1
17	JFT147-14B	Adjustment	调节器	1
18	WD100X90	Tail lamp	倒车后照灯	1
19	LTD3092	Caution light	警示灯	1 12V,选用
20	SARL-112DM	Relay	启动继电器	1
21	SARL-112DM	Relay	预热继电器	1
22	SJ 12V	Time relay	时间继电器	1
23	BX9052-D30A	Fusibl link wire	易熔丝	1
24	YSFQ1	Sensor	油水分离器	1
25	JK208A	Reverse switch	倒车灯开关	1 变速箱配
26	JK205	Brake switch	制动灯开关	1



序号 Item No	图号 Part No	零部件名称 Description	件数 Q'ty	备注 Remark
27	JK208A	Neutral start switch 空档启动开关	1	变速箱配
28	QD1315A	Starter 起动机	1	发动机配
29	JF131A	Alternator 发电机	1	发动机配
30	HL262	Oil quantity sensor 油量传感器	1	
31	YG-2(Z1/4)	Fuel pressure warning switch 油压报警器	1	发动机配
32	-	Water temperature sensor 水温传感器	1	发动机配
33	-	Horn push-button 喇叭按钮	1	方向盘配
34	SARL-112DM	Lgnition relay 点火继电器	1	

FD10/15/18(T)-MG1~2

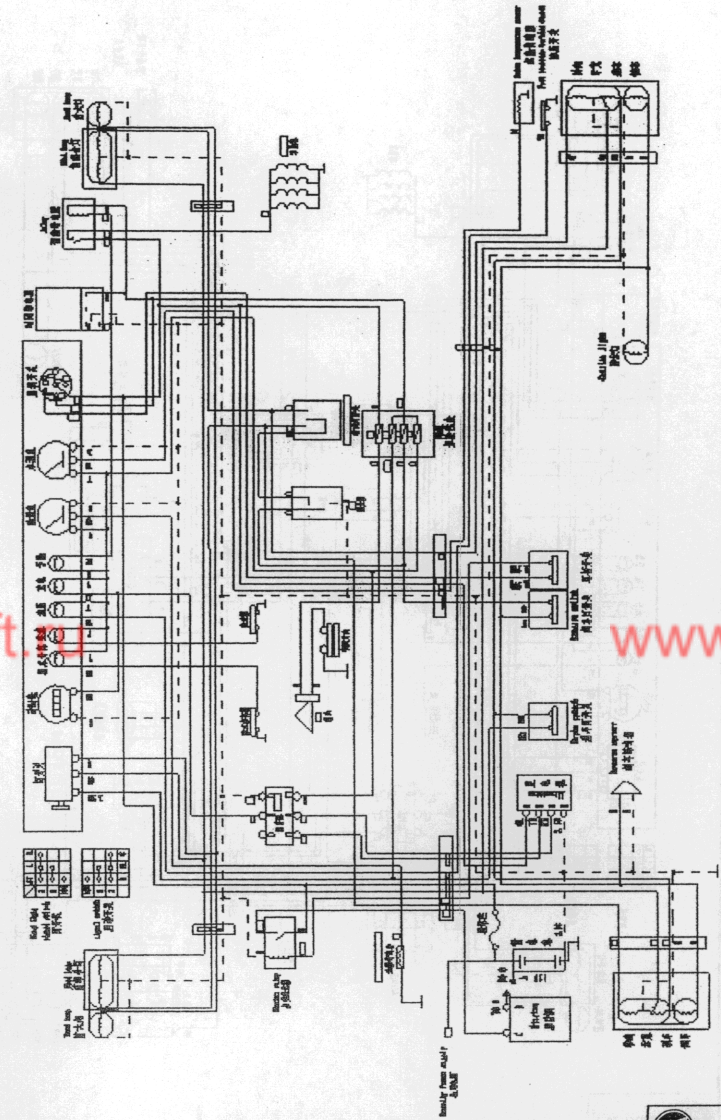

电气系统/ELECTRIC SYSTEM

FD10/15/18(T)-MGI3

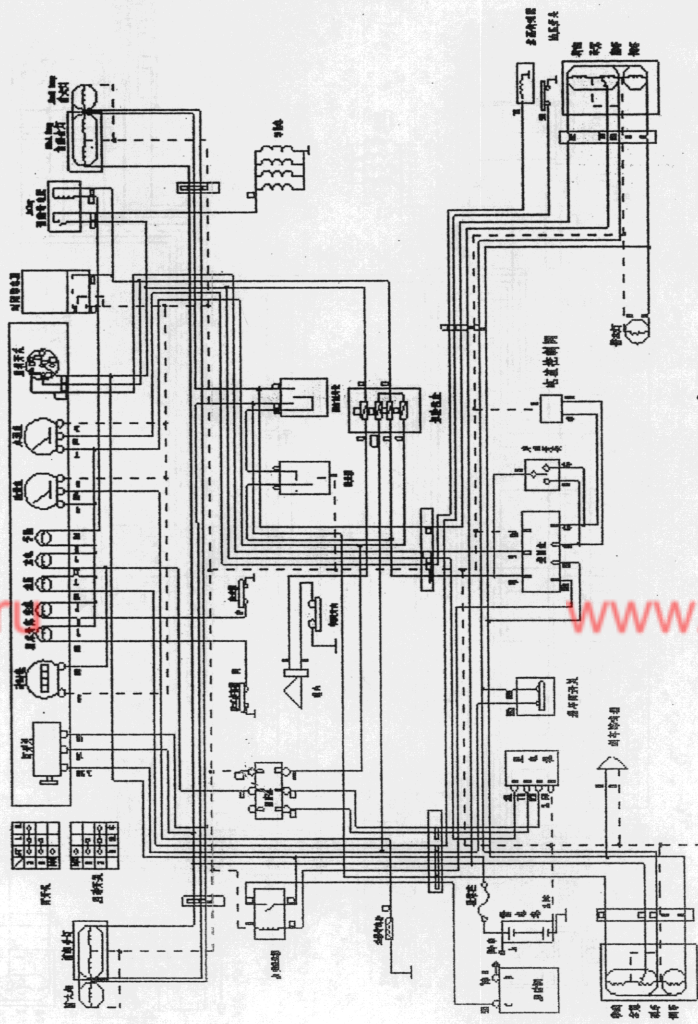

序号 Item No	图号 Part No	零部件名称 Description	件数 Q'ty	备注 Remark
1	BL84-107	Head lamp ass'y	2	前大灯 12V
2	Z-QX 85X85	Front combination lamp ass'y	2	前组合灯 12V
3	Z-HXF 220X55	Rear combination lamp ass'y	2	后组合灯 12V
4	6-QW-90	Battery	1	蓄电池
5	M3042401000	Wiring harness	1	主线束
6	HZB908W1-MKS	Combination	1	组合仪表 全英文显示
7	HZB908W6-MKS	Combination	1	组合仪表 西班牙文显示
8	CYPC-012	Combination	1	组合仪表 选配
9	DL125G	Horn	1	喇叭
10	SGQ-154	Flasher Unit	1	闪光器
11	JK808	Switch, turn signal	1	转向灯开关
12	JK411	Key switch	1	启动开关
13	JK211	Lamp switch	1	灯开关
14	WG424(R1/2)	Oil warning switch	1	油温报警器
15		Electric box	1	电气盒
16	DJB-12B	Back buzzer	1	倒车蜂鸣器
17	JFT147-14B	Adjustment	1	调节器
18	WD100X90	Tail lamp	1	倒车后照灯
19	LTD3092	Caution light	1	警示灯 12V, 选用
20	SARL-112DM	Relay	1	启动继电器
21	SARL-112DM	Relay	1	预热继电器
22	SJ 12V	Relay	1	时间继电器
23	BX9052-D30A	Fusibl link wire	1	易熔丝
24	YSFQ1	Sensor	1	油水分离器
25	H24C2-40601	Control box	1	控制盒
26	JK205	Brake switch	1	制动灯开关



电气系统/ELECTRIC SYSTEM

FD10/15/18(T)-MGI3

序号 Item No	图号 Part No	零部件名称 Description	件数 Qty	备注 Remark
27	JK208	Direction switch	方向开关	1
28	QD1315A	Starter	起动机	1 发动机配
29	JF131A	Alternator	发电机	1 发动机配
30	HL262	Oil quantity sensor	油量传感器	1
31	YG-2(Z1/4)	Fuel pressure warning switch	油压报警器	1 发动机配
32	-	Water temperature sensor	水温传感器	1 发动机配
33	-	Horn push-button	喇叭按钮	1 方向盘配
34	SARL-112DM	Lgnition relay	点火继电器	
35	-	Valve	电液控制阀	变速箱配

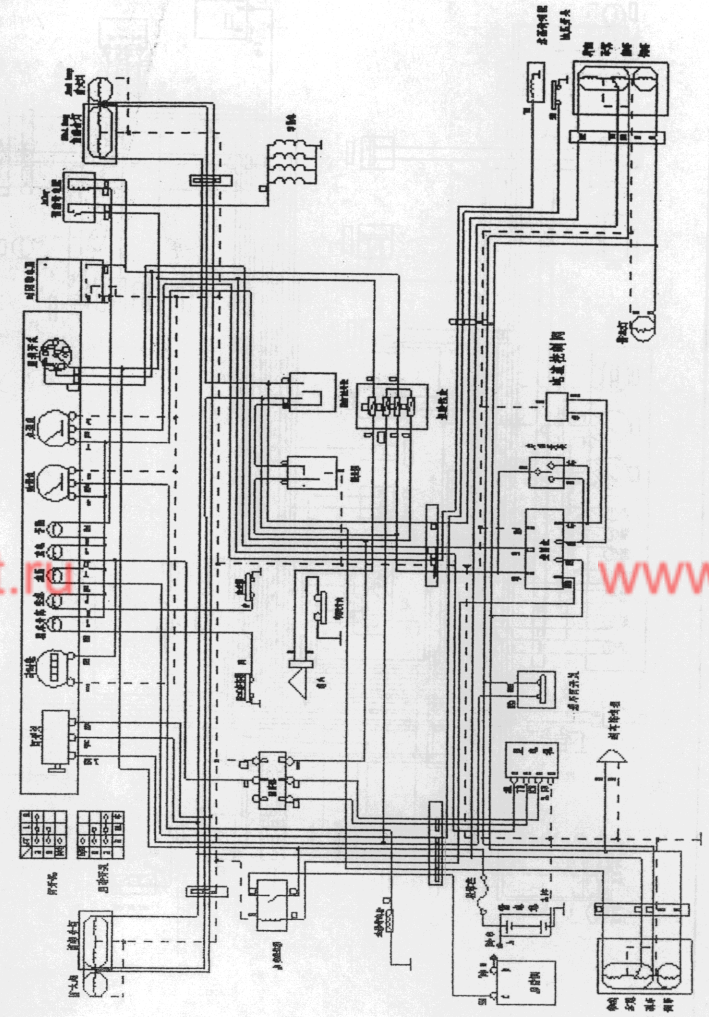

FD10/15/18(T)-MWA1~2

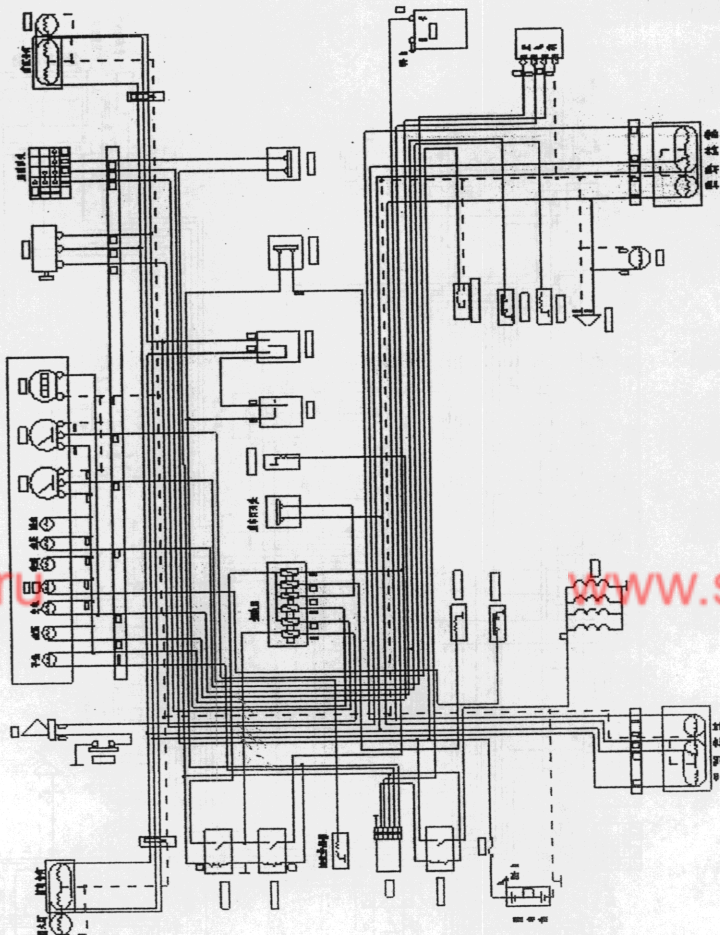

序号 Item No	图号 Part No	零部件名称 Description	件数 Q'ty	备注 Remark
1	BL84-107	Head lamp ass'y	前大灯	2 12V
2	Z-QX 85X85	Front combination lamp ass'y	前组合灯	2 12V
3	Z-HXF 220X55	Rear combination lamp ass'y	后组合灯	2 12V
4	6-QW-90	Battery	蓄电池	1
5	M3032403000	Wiring harness	主线束	1
6	HZB908W1-MKS	Combination	组合仪表	1 全英文显示
7	HZB908W6-MKS	Combination	组合仪表	1 西班牙文显示
8	CYPC-012	Combination	组合仪表	1 选配
9	-	Fuel outoff switch	燃油切断开关	1 发动机配
10	DL125G	Horn	喇叭	1
11	SGQ-154	Flasher Unit	闪光器	1
12	JK802	Switch, turn signal	转向灯开关	1
13	JK411	Key switch	启动开关	1
14	JK211	Lamp switch	灯开关	1
15	WG424(R1/2)	Oil warning switch	油温报警器	1
16	-	Electric box	电气盒	1
17	DJB-12B	Back buzzer	倒车蜂鸣器	1
18	WD100X90	Tail lamp	后灯	1
19	LTD3092	Caution light	警示灯	1 12V, 选用
20	SARL-112DM	Relay	启动继电器	1
21	SARL-112DM	Relay	预热继电器	1
22	8970405010	Time relay	时间继电器	1
23	8943197002	Preheater	预热塞	1
24	BX9052-D30A	Fusibl link wire	易熔丝	1
25	SARL-112DM	Lgnition relay	点火继电器	1
26	JK208A	Reverse switch	倒车灯开关	1 变速箱配



序号 Item No	图号 Part No	零部件名称 Description	件数 Q'ty	备注 Remark
27	JK205	Brake switch 制动灯开关	1	
28	JK208A	Neutral start switch 空档启动开关	1	变速箱配
29		Horn push-button 喇叭按钮	1	方向盘配
30	8944532120	Starter 起动机12V 2KW	1	发动机配
31	5812003411	Alternator 发电机12V 35A	1	发动机配
32	HL262	Oil quantity sensor 油量传感器	1	
33	5824100122	Fuel pressure warning switch 油压报警器	1	发动机配
34	WG-2(16x1.5)	Water temperature sensor 水温传感器	1	

FD10/15/18(T)-MWA1~2

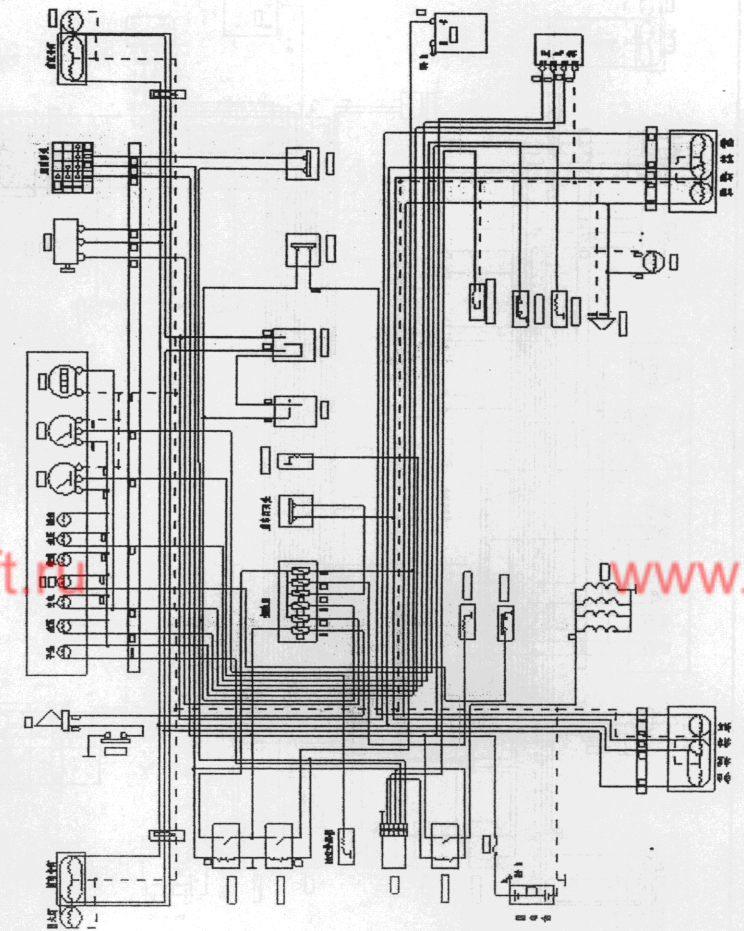

FD10/15/18(T)-MWA3

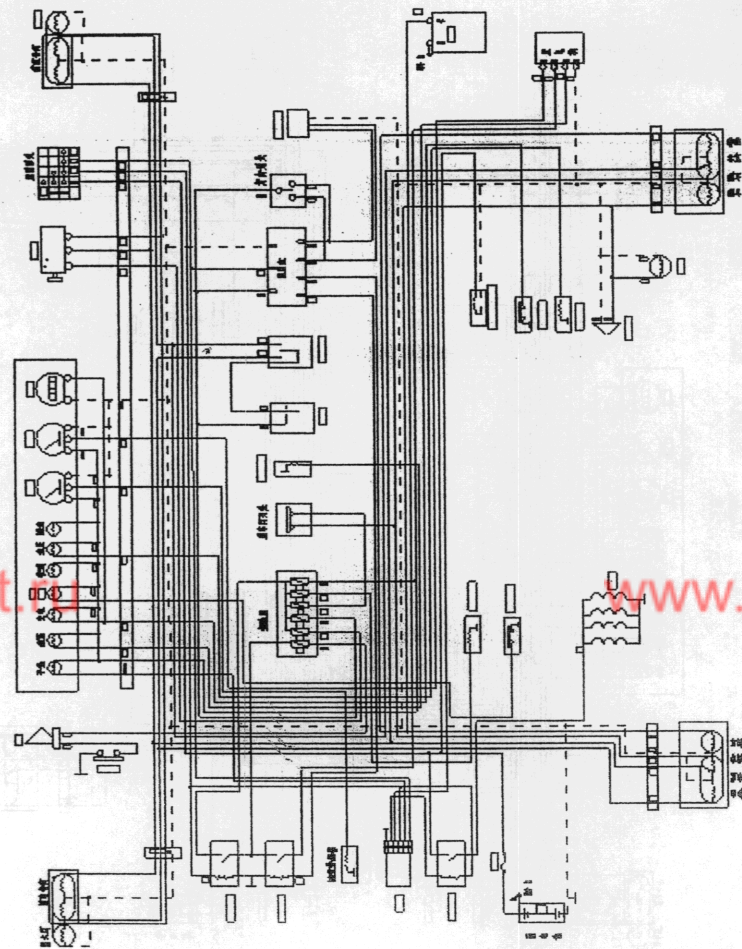

序号 Item No	图号 Part No	零部件名称 Description	件数 Qty	备注 Remark
1	BL84-107	Head lamp ass'y	2	前大灯 12V
2	Z-QX 85X85	Front combination lamp ass'y	2	前组合灯 12V
3	Z-HXF 220X55	Rear combination lamp ass'y	2	后组合灯 12V
4	6-QW-90	Battery	1	蓄电池
5	M3042403000	Wiring harness	1	主线束
6	HZB908W1-MKS	Combination	1	组合仪表 全英文显示
7	HZB908W6-MKS	Combination	1	组合仪表 西班牙文显示
8	CYPC-012	Combination	1	组合仪表 选配
9		Fuel out off switch	1	燃油切断开关 发动机配
10	DL125G	Horn	1	喇叭
11	SGQ-154	Flasher Unit	1	闪光器
12	JK802	Switch, turn signal	1	转向灯开关
13	JK411	Key switch	1	启动开关
14	JK211	Lamp switch	1	灯开关
15	WG424(R12)	Oil warning switch	1	油温报警器
16	-	Electric box	1	电气盒
17	DJB-12B	Back buzzer	1	倒车蜂鸣器
18	H24C2-40601	Control box	1	控制盒
19	WD100X90	Tail lamp	1	后灯
20	LTD3092	Caution light	1	警示灯 12V, 选用
21	SARL-112DM	Relay	1	启动继电器
22	SARL-112DM	Relay	1	预热继电器
23	8970405010	Time relay	1	时间继电器 发动机配
24	8943197002	Preheater	1	预热塞
25	BX9052-D30A	Fusibl link wire	1	易熔丝
26	SARL-112DM	Lgnition relay	1	点火继电器



电气系统/ELECTRIC SYSTEM

FD10/15/18(T)-MWA3

序号 Item No	图号 Part No	零部件名称 Description	件数 Q'ty	备注 Remark
27	JK205	Brake switch 制动灯开关	1	
28	JK208	Direction switch 方向开关	1	
29	-	Horn push-button 喇叭按钮	1	方向盘配
30	8944532120	Starter 起动机12V 2KW	1	发动机配
31	5812003411	Alternator 发电机12V 35A	1	发动机配
32	HL262	Oil quantity sensor 油量传感器	1	
33	5824100122	Fuel pressure warning switch 油压报警器	1	发动机配
34	WG-2(16 x 1.5)	Water temperature sensor 水温传感器	1	
35	-	Valve 电液控制阀	1	变速箱配

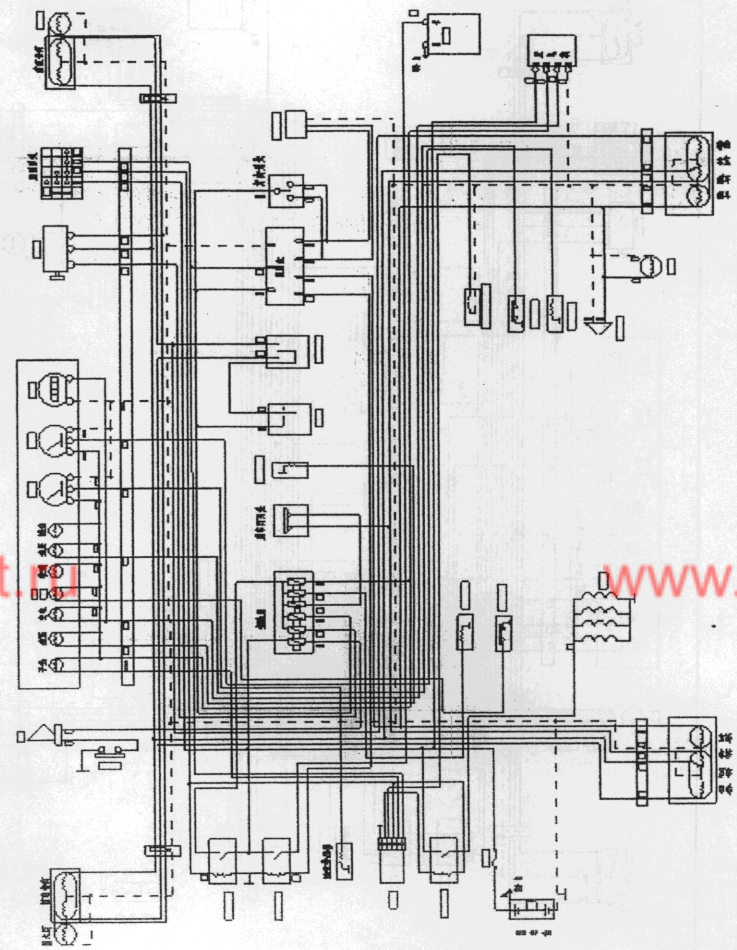

FD10/15/18(T)-MWC1~2

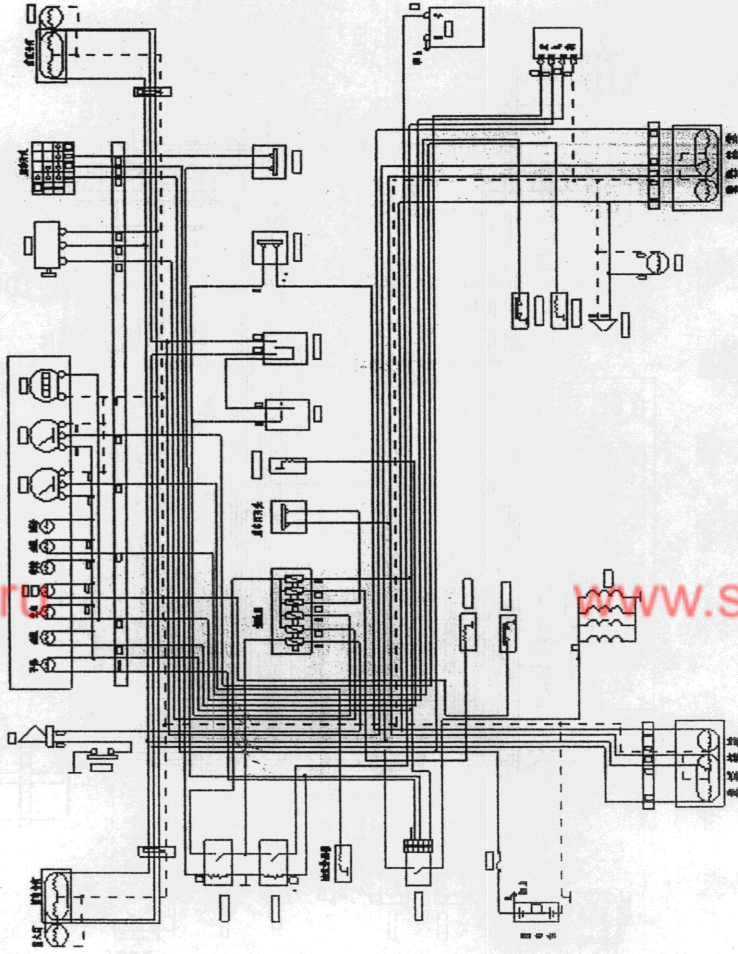

序号 Item No	图号 Part No	零部件名称 Description	件数 Q'ty	备注 Remark
1	BL84-107	Head lamp ass'y	前大灯 2	12V
2	Z-QX 85X85	Front combination lamp ass'y	前组合灯 2	12V
3	Z-HXF 220X55	Rear combination lamp ass'y	后组合灯 2	12V
4	6-QW-90	Battery	蓄电池 1	
5	M2532404000	Wiring harness	主线束 1	
6	HZB908W2-MKS	Combination	组合仪表 1	全英文显示
7	HZB908W7-MKS	Combination	组合仪表 1	西班牙文显示
8	CYPC-012	Combination	组合仪表 1	选配
9	DL125G	Horn	喇叭 1	
10	SGQ-154	Flasher Unit	闪光器 1	
11	JK802	Switch, turn signal	转向灯开关 1	
12	JK411	Key switch	启动开关 1	
13	JK211	Lamp switch	灯开关 1	
14	WG424(R1/2)	Oil warning switch	油温报警器 1	
15		Electric box	电气盒 1	
16	DJB-12B	Back buzzer	倒车蜂鸣器 1	
17	119717-77800	Preheater	预热塞 1	发动机配
18	WD100X90	Tail lamp	后工作灯 1	
19	LTD3092	Caution light	警示灯 1	12V, 选用
20	SARL-112DM	Relay	点火继电器 1	
21	SARL-112DM	Relay	启动继电器 1	
22	ST12V	Time Relay	时间继电器 1	发动机配
23	SARL-112DM	Relay	预热继电器 1	
24	JK208A	Reverse switch	倒车灯开关 1	变速箱配
25	JK205	Brake switch	制动灯开关 1	
26	JK208A	Neutral start switch	空档启动开关 1	变速箱配



电气系统/ELECTRIC SYSTEM

FD10/15/18(T)-MWC1-2

序号 Item No	图号 Part No	零部件名称 Description	件数 Q'ty	备注 Remark
27	129900-77010	Starter 起动机12V 3KW	1	发动机配
28	119836-77201	Alternator 发电机12V 40A	1	发动机配
29	HL262	Oil quantity sensor 油量传感器	1	
30	114250-39450	Fuel pressure warning switch 油压报警器	1	发动机配
31	124250-49351	Water temperature sensor 水温传感器	1	发动机配
32	129917-55800	Sensor 油水分离器	1	发动机配
33	-	Horn push-button 喇叭按钮	1	方向盘配
34	BX9052-D30A	Fusibl link wire 易熔丝	1	
35	-	Shut-down electromagnet 燃油切断阀	1	发动机配

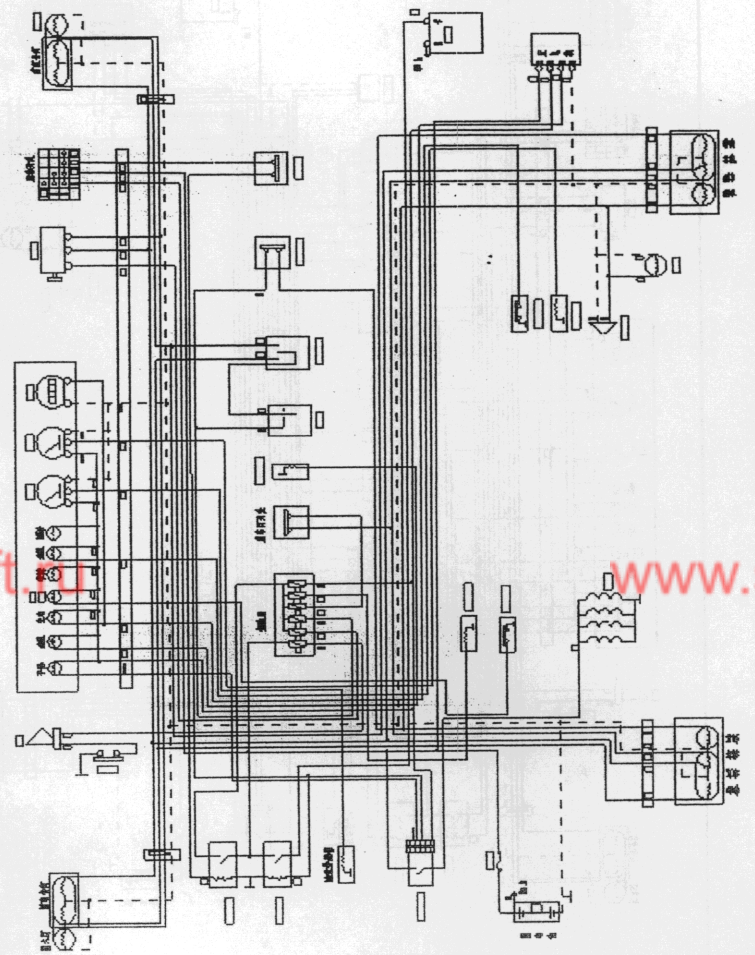

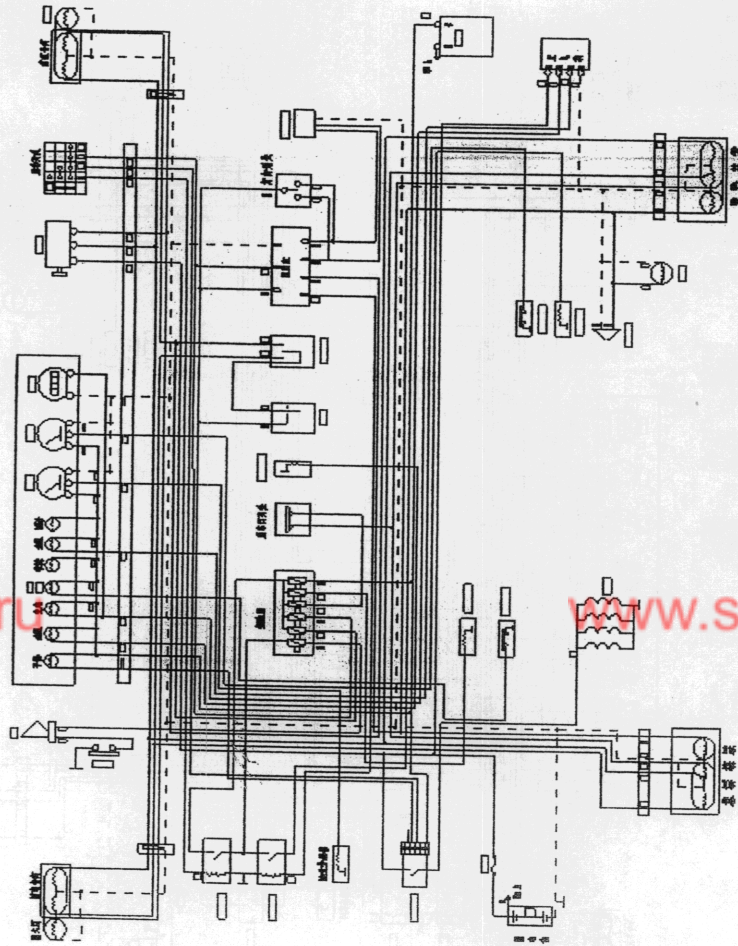

序号 Item No	图号 Part No	零部件名称 Description	件数 Q'ty	备注 Remark
1	BL84-107	Head lamp ass'y	2	前大灯 12V
2	Z-QX 85X85	Front combination lamp ass'y	2	前组合灯 12V
3	Z-HXF 220X55	Rear combination lamp ass'y	2	后组合灯 12V
4	6-QW-90	Battery	1	蓄电池
5	M2542404000	Wiring harness	1	主线束
6	HZB908W2-MKS	Combination	1	组合仪表 全英文显示
7	HZB908W7-MKS	Combination	1	组合仪表 西班牙文显示
8	CYPC-012	Combination	1	组合仪表 选配
9	DL125G	Horn	1	喇叭
10	SGQ-154	Flasher Unit	1	闪光器
11	JK802	Switch, turn signal	1	转向灯开关
12	JK208	Direction switch	1	方向开关
13	JK411	Key switch	1	启动开关
14	JK211	Lamp switch	1	灯开关
15	WG424(R1/2)	Oil warning switch	1	油温报警器
16	-	Electric box	1	电气盒
17	DJB-12B	Back buzzer	1	倒车蜂鸣器
18	119717-77800	Preheater	1	预热塞 发动机配
19	WD100X90	Tail lamp	1	后工作灯
20	LTD3092	Caution light	1	警示灯 12V, 选用
21	SARL-112DM	Relay	1	点火继电器
22	SARL-112DM	Relay	1	启动继电器
23	ST12V	Time Relay	1	时间继电器 发动机配
24	SARL-112DM	Relay	1	预热继电器
25	H24C2-40601	Control box	1	控制盒
26	JK205	Brake switch	1	制动灯开关



电气系统/ELECTRIC SYSTEM

FD10/15/18(T)-MWC3

序号 Item No	图号 Part No	零部件名称 Description	件数 Q'ty	备注 Remark
27	129900-77010	Starter 起动机12V 3KW	1	发动机配
28	119836-77201	Alternator 发电机12V 40A	1	发动机配
29	HL262	Oil quantity sensor 油量传感器	1	
30	114250-39450	Fuel pressure warning switch 油压报警器	1	发动机配
31	124250-49351	Water temperature sensor 水温传感器	1	发动机配
32	129917-55800	Sensor 油水分离器	1	发动机配
33	-	Horn push-button 喇叭按钮	1	方向盘配
34	BX9052-D30A	Fusibl link wire 易熔丝	1	
35	-	Shut-down electromagnet 燃油切断阀	1	发动机配
36	-	Valve 电液控制阀	1	变速箱配

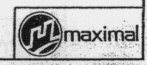
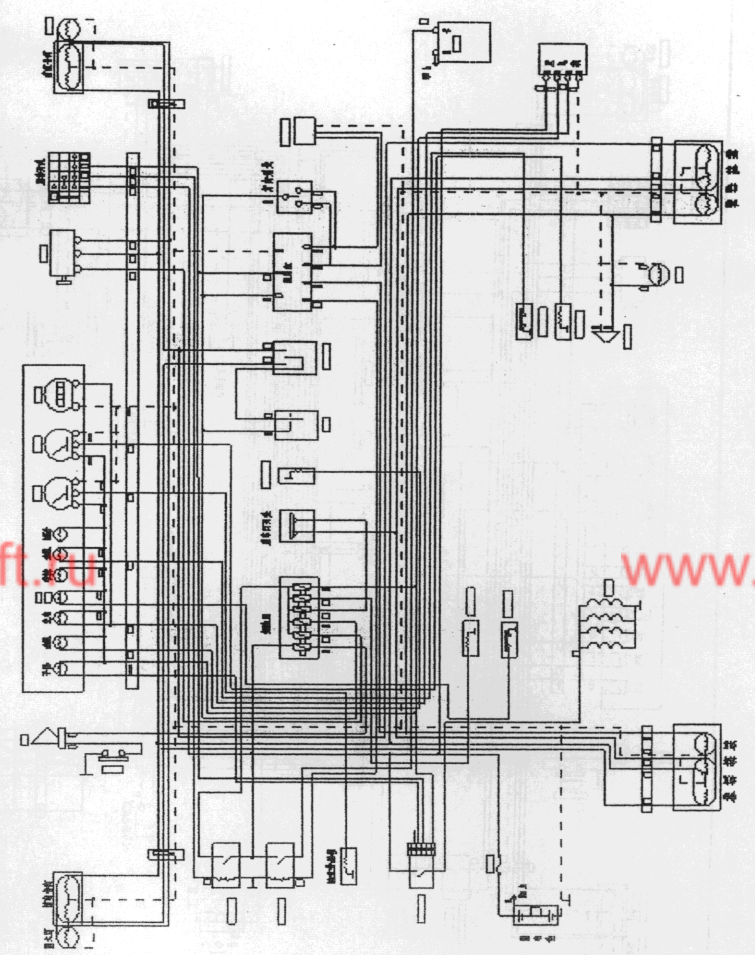

FG10/15/18T-MGA3
FGL10/15/18T-MGA3

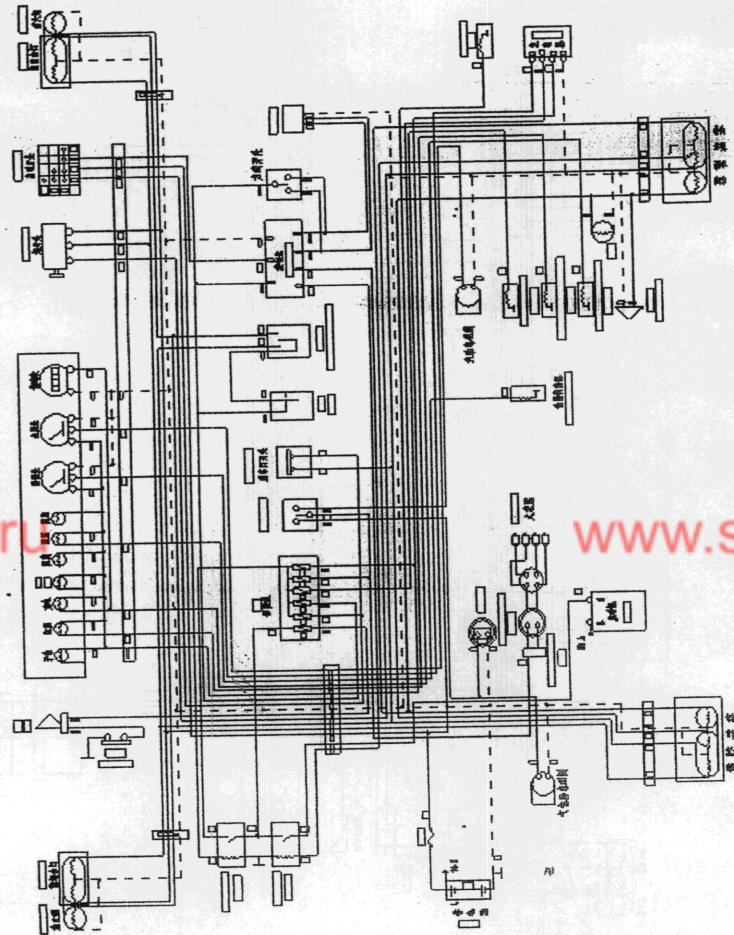

序号 Item No	图号 Part No	零部件名称 Description	件数 Q'ty	备注 Remark
1	BL84-107	Head lamp ass'y	2	前大灯 12V
2	Z-QX 85X85	Front combination lamp ass'y	2	前组合灯 12V
3	Z-HXF 220X55	Rear combination lamp ass'y	2	后组合灯 12V
4	6-QW-60	Battery	1	蓄电池
5	M2522401000	Wiring harness	1	主线束 FG20/25
6	HZB908E-MKS	Combination	1	组合仪表
7	-	Vaporization	1	汽化器 发动机配
8	DL125G	Horn	1	喇叭
9	SGQ-154	Flasher Unit	1	闪光器
10	JK802	Switch, turn signal	1	转向灯开关
11	JK411	Key switch	1	启动开关
12	JK211	Lamp switch	1	灯开关
13	WG424(R1/2)	Oil warning switch	1	油温报警器
14	-	Electric box	1	电气盒
15	DJB-12B	Back buzzer	1	倒车蜂鸣器 www.starlift.ru
16	-	Auto-choke relay	1	汽化器继电器 发动机配
17	WD100X90	Tail lamp	1	后灯
18	LTD3092	Caution light	1	警示灯 12V, 选用
19	SARL-112DM	Relay	1	启动继电器
20	SARL-112DM	Lgnition relay	1	点火继电器
21	H24C2-40601	Control box	1	控制盒
22	-	Horn push-button	1	喇叭按钮 方向盘配
23	BX9052-D30A	Fusibl link wire	1	易熔丝
24	-	Current separator	1	分电器
25	JK205	Brake switch	1	制动灯开关
26	JK208	Direction switch	1	方向开关

电气系统/ELECTRIC SYSTEM

序号 Item No	图号 Part No	零部件名称 Description	件数 Q'ty	备注 Remark
27	QDY1253	Starter	1	发动机配
28	JF131A	Alternator	1	发动机配
29	HL262	Oil quantity sensor	1	
30	-	Fuel pressure warning switch	1	发动机配
31	-	Water temperature sensor	1	发动机配
32	-	Lgnition winding	1	发动机配
33	-	Spark plug	1	发动机配
34	-	Valve	1	变速箱配

FG10/15/18T-MGA3
FGL10/15/18T-MGA3

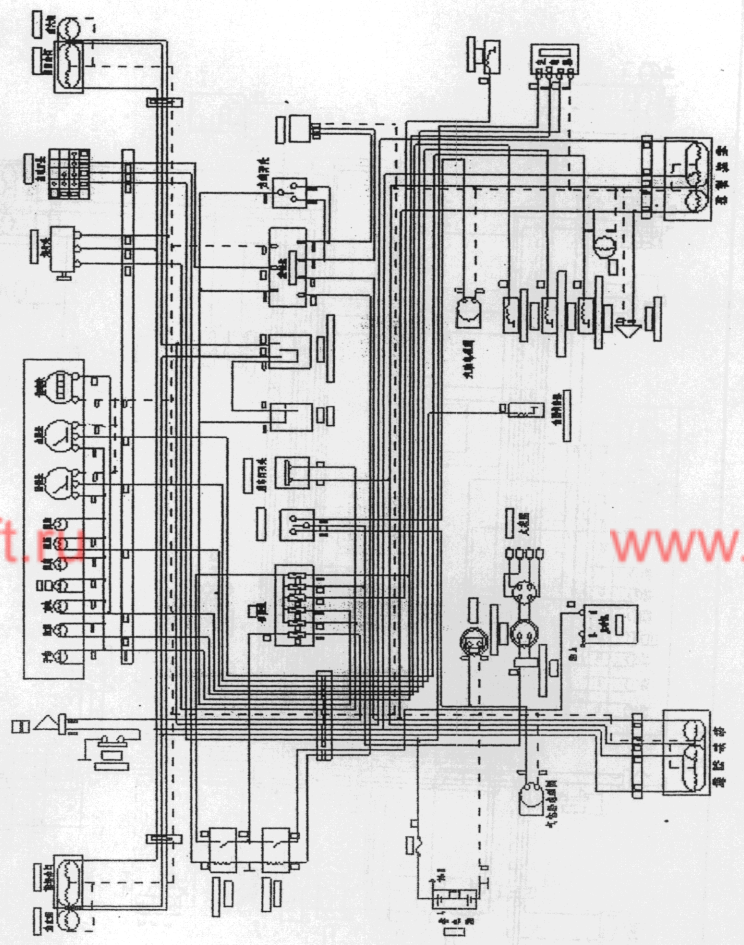

电气系统/ELECTRIC SYSTEM

FG10/15/18T-MWB3
FGL10/15/18T-MWB3

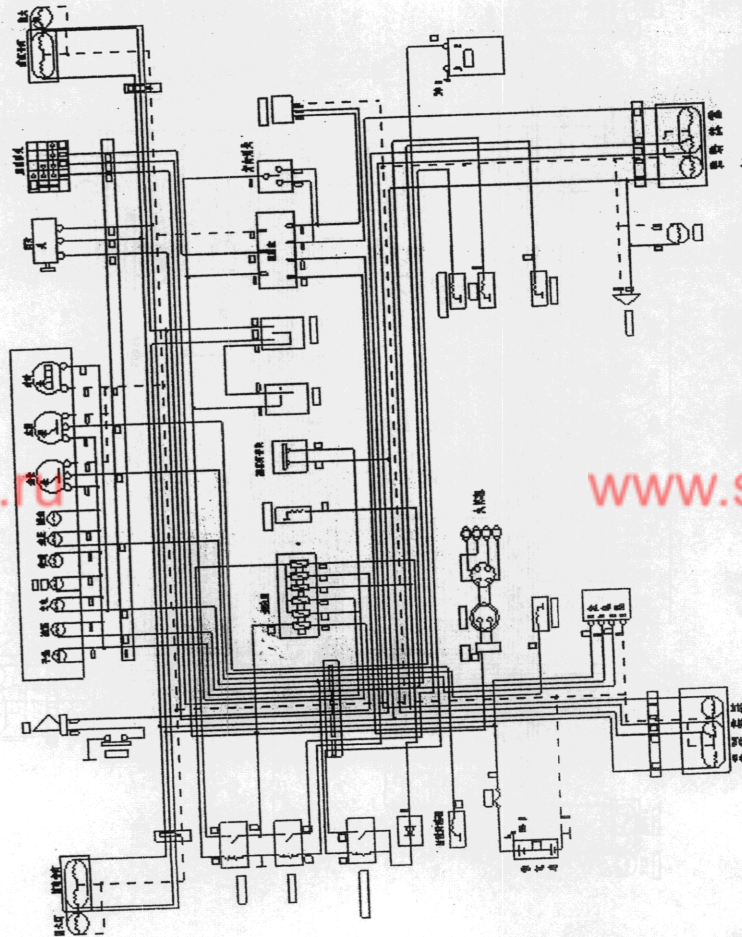

序号 Item No	图号 Part No	零部件名称 Description	件数 Q'ty	备注 Remark
1	BL84-107	Head lamp ass'y	2	前大灯 12V
2	Z-QX 85X85	Front combination lamp ass'y	2	前组合灯 12V
3	Z-HXF 220X55	Rear combination lamp ass'y	2	后组合灯 12V
4	6-QW-60	Battery	1	蓄电池
5	M2522402000	Wiring harness	1	主线束
6	HZB908W4-MKS	Combination	1	组合仪表
7	-	Vaporization	1	汽化器 发动机配
8	DL125G	Horn	1	喇叭
9	SGQ-154	Flasher Unit	1	闪光器
10	JK802	Switch, turn signal	1	转向灯开关
11	JK411	Key switch	1	启动开关
12	JK211	Lamp switch	1	灯开关
13	WG424(R1/2)	Oil warning switch	1	油温报警器
14	-	Electric box	1	电气盒
15	DJB-12B	Back buzzer	1	倒车蜂鸣器
16	-	Auto-choke relay	1	汽化器继电器 发动机配
17	WD100X90	Tail lamp	1	后灯
18	LTD3092	Caution light	1	警示灯 12V, 选用
19	SARL-112DM	Relay	1	启动继电器
20	SARL-112DM	Lgnition relay	1	点火继电器
21	H24C2-40601	Control box	1	控制盒
22	-	Horn push-button	1	喇叭按钮 方向盘配
23	BX9052-D30A	Fusibl link wire	1	易熔丝
24	22100-60K10	Current separator	1	分电器
25	JK205	Brake switch	1	制动灯开关
26	JK208	Direction switch	1	方向开关



序号 Item No	图号 Part No	零部件名称 Description	件数 Q'ty	备注 Remark
27	23300-K9160	Starter	1	发动机配
28	23100-50K10	Alternator	1	发动机配
29	HL262	Oil quantity sensor	1	发动机配
30	25240-89911	Fuel pressure warning switch	1	发动机配
31	-	Water temperature sensor	1	发动机配
32	22020-55K10	Lgnition winding	1	发动机配
38	22401-W8914	Spark plug	1	发动机配
34	-	Valve	1	变速箱配

FG10/15/18T-MWB3
FGL10/15/18T-MWB3

