

CPQ, CPQD20, 25, 30-R6  
 CPQ, CPQD20H, 25H-R11  
 CPQ, CPQD30-R12  
 CPQ, CPQD35-R3, R4  
 CPC, CPCD20, 25, 30-W7, W8, W9  
 CPC, CPCD20, 25, 30, 35-HJ, D  
 CPC, CPCD35-W4, W5, W6

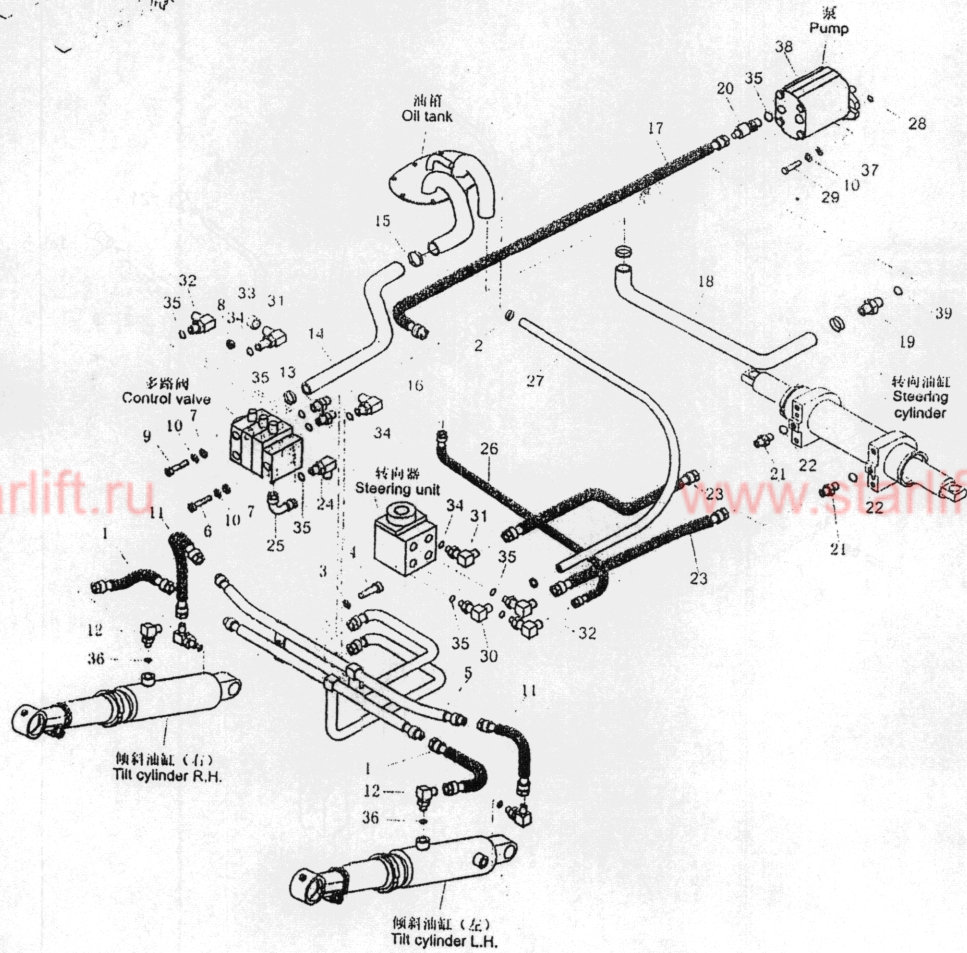

序号 Item No	图号 Part No	零件名称 Description	件数 Qty	备注 Remark
A	HRE24C7601 E24C7-60002	Hydraulic system 液压管路系统	1	21, 2.5t
-	HRE24C7601 E24N7-60001	Hydraulic system 液压管路系统	1	31, 3.5t
01	E24C7-60271	Hose H.P. 高压胶管总成	2	
02	Z4503-16025	Clip 双钢丝卡箍	2	
03	B5050-00006	Washer, lock 垫圈6	9	GB93-87
04	B0330-06025	Bolt 螺栓M6X25	2	GB5783-86
05	E24C7-60251	Steel pipe ass'y 倾斜缸钢管总成	1	
06	B0530-10025	Bolt 螺栓M10X1.25X25	1	GB5786-86
07	B5310-00010	Washer 垫圈10	10	GB97.1-85
08	B4223-00010	Nut 螺母M10	4	GB6171-86
09	B0330-10040	Bolt 螺栓M10X40	4	GB5783-86
10	B5050-00010	Washer, lock 垫圈10	12	GB93-87
11	Z7801-0603312	Hose H.P. 高压胶管	2	
12	JT8022-96051	Elbow(Inc.36) 直角接头(包括36)	4	
13	JT6021-20021	Nipple(Inc.35) 直通接头(包括35)	2	
14	H24C7-60231	Hose 多路阀回油管	1	二至四片阀 Two to four-throw
-	H24C7-60241	Hose 多路阀回油管	1	五片阀 Five-throw
15	Z4590-00045	Clip 双钢丝卡箍	8	
16	JT8022-34011	Elbow(Inc.34) 直角接头(包括34)	1	
17	Z7802-13117	Hose H.P. 高压胶管	1	
18	H24C7-60251	Hose 吸油管	1	CPC(D)35-W5, W6 CPC(D)20-30-W7, W9 CPQ(D)30-R12 CPQ(D)20H, 25H-R11 CPC(D)35-R3, R4 CPC(D)35-W4 CPC(D)20, 25-D, HJ CPC(D)30, 35-D, HJ CPQ(D)20-30-R6 CPC(D)20-30-W8
-	H24C7-60261	Hose 吸油管	1	
19	JT7021-10011	Nipple(Inc.39) 直通接头(包括39)	2	
20	E24C7-60291	Elbow(Inc.35) 齿轮油泵接头(包括35)	1	CPC(D)35-W5 CPC(D)35-W6 CPC(D)20-30-W7, W9 CPQ(D)30-R12 CPQ(D)20H, 25H-R11 CPC(D)35-R3, R4 CPC(D)35-W4
-	E24C7-60321	Elbow(Inc.35) 齿轮油泵接头(包括35)	1	

G

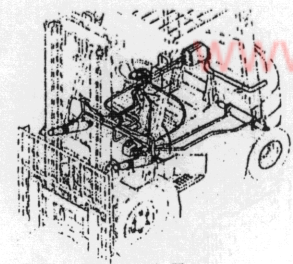

序号 Item No	图号 Part No	零件名称 Description	件数 Q'ty	备注 Remark
20	E24C7-60321	Elbow(Inc.35) 齿轮油泵接头(包括35)	1	CPC(D)20,25-D,HJ CPC(D)30,35-D,HJ CPQ(D)20-30-R6 CPC(D)20-30-W8
21	JT8025-96031	Nipple 直通接头	1	
22	Z6003-01802	O-ring 0型密封圈18X2.4	2	
23	Z7801-08208	Hose H.P. 高压胶管	2	2t,2.5t
-	Z7801-08216	Hose H.P. 高压胶管	2	3t,3.5t
24	JT8022-34031	Elbow(Inc.35) 直角接头(包括35)	1	
25	JT8022-96021	Nipple 过渡接头	1	
26	HRE22A7605 E22A7-60501	Hose H.P. 高压胶管	1	
27	Z7300-13160	Hose 低压胶管	1	
28	Z3657-12001	Packing 垫	2	柴油机
-	Z6053-08253	O-ring 0型密封圈82.5X3.55	2	汽油机 GB3452.1-82
29	B0330-10030	Bolt 螺栓M10X30	2	柴油机 GB5783-86
-	B0430-10030	Bolt 螺栓M10X1.25X30	2	汽油机 GB5785-86
30	JT6022-22041	Elbow(Inc.35) 直角接头(包括35)	1	
31	JT8022-96041	Elbow(Inc.34) 直角接头(包括34)	2	三片阀Three-throw
-	-	-	3	四片阀Four-throw
-	-	-	4	五片阀Five-throw
32	JT8022-96031	Elbow(Inc.35) 直角接头(包括35)	1	三片阀Three-throw
-	-	-	2	四片阀Four-throw
-	-	-	3	五片阀Five-throw
33	E12A7-60251	Plug 堵头	2	三片阀Three-throw
-	-	-	4	四片阀Four-throw
-	-	-	6	五片阀Five-throw
34	Z6003-02202	O-ring 0型密封圈22X2.4	9	GB1235-76 三片阀Three-throw
-	-	-	10	GB1235-76 四片阀Four-throw
-	-	-	11	GB1235-76 五片阀Five-throw
35	Z6004-02202	O-ring 0型密封圈22X2.4	9	GB1235-76 三片阀Three-throw
-	-	-	10	GB1235-76 四片阀Four-throw
-	-	-	11	GB1235-76 五片阀Five-throw

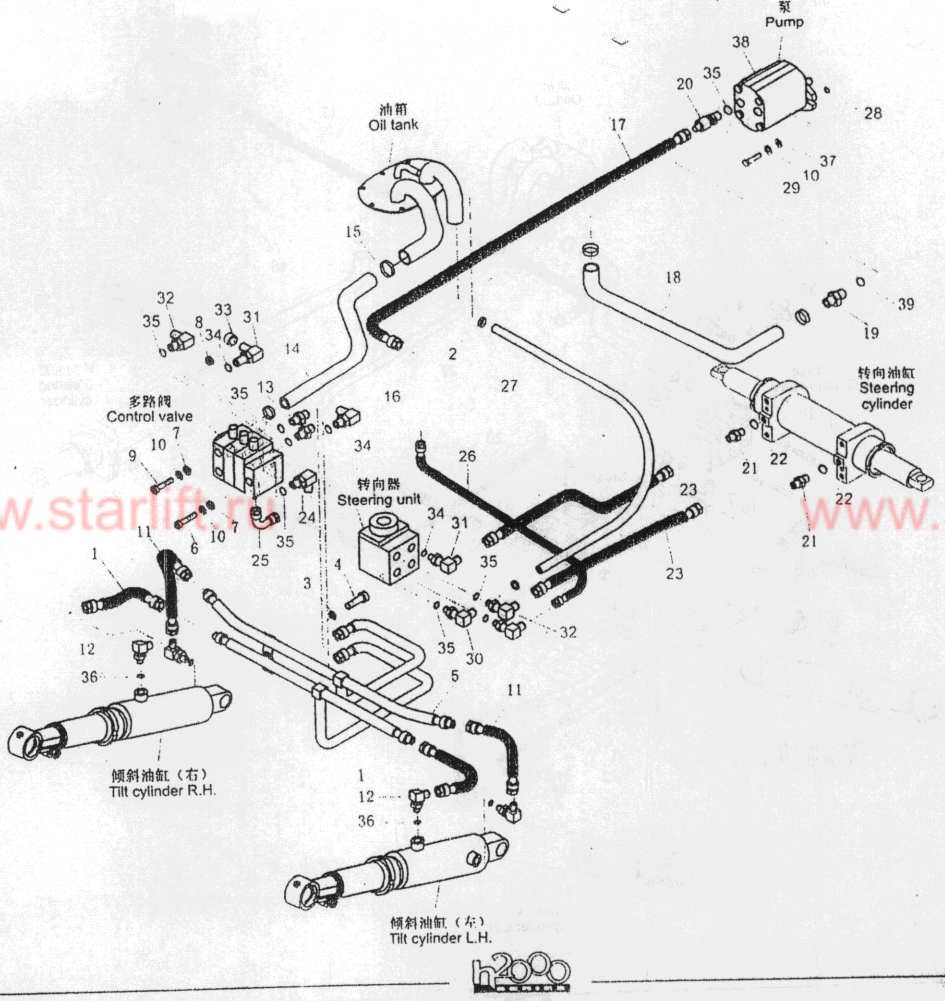

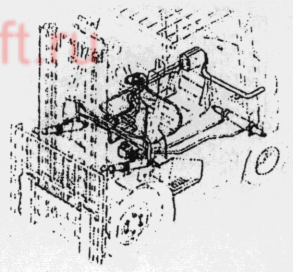

- CPQ, CPQD20, 25, 30-R6
- CPQ, CPQD20H, 25H-R11
- CPQ, CPQD30-R12
- CPQ, CPQD35-R3, R4
- CPC, CPCD20, 25, 30-W7, W8, W9
- CPC, CPCD20, 25, 30, 35-HJ, D
- CPC, CPCD35-W4, W5, W6

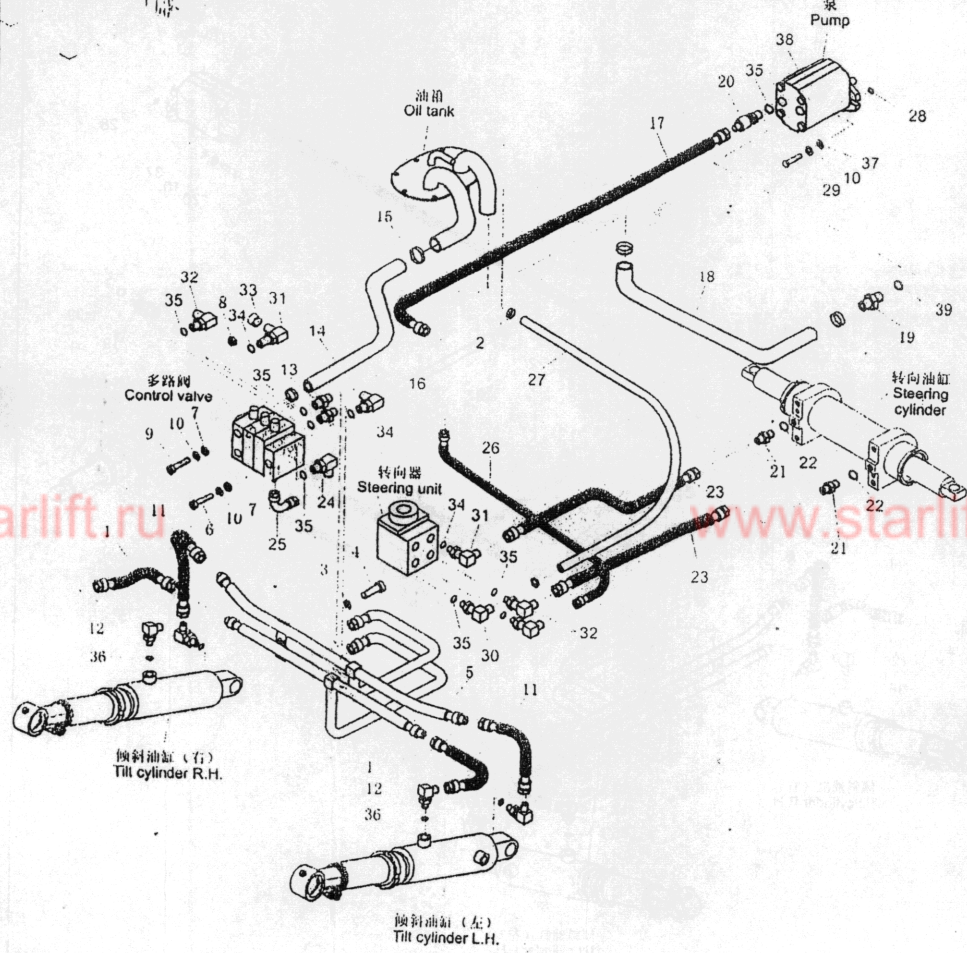

序号 Item No	图号 Part No	零件名称 Description	件数 Q'ty	备注 Remark
36	Z6003-01502	O-ring O型密封圈15X2.4	4	GB1235-76
37	B5320-00010	Washer 垫圈10	2	GB97.1-85
38	HRH24C7101 H24C7-10001	Gear pump 泵	1	CPQ(D)20,25-R6 CPC(D)20-30-W8 CPC(D)20,25-D,HJ
-	HRH24C7101 H24C7-10011	Gear pump 泵	1	CPQ(D)20H,25H-R11 CPQ(D)30-R6,R12 CPC(D)30-D,HJ CPQ(D)35-R3,R4 CPC(D)35-W4,D,HJ
-	HRH24C7101 H25S7-10001	Gear pump 泵	1	CPC(D)20,25-W7,W9
-	HRH24C7101 H25S7-10011	Gear pump 泵	1	CPC(D)30-W7,W9 CPC(D)35-W5,W6
39	Z6051-02804	O-ring O型密封圈28X3.55	1	GB1235-76

G

图109/FIG 109

液压系统/HYDRAULIC SYSTEM (EX-B)

G7

序号 Item No	图号 Part No	零部件名称 Description	件数 Q'ty	备注 Remark
A	HRH24C7601	Hydraulic system	1	21.2.5t
-	H24C7-60002	Hydraulic system	1	31.3.5t
-	HRH24C7601	Hydraulic system	1	31.3.5t
-	H24N7-60001	Hydraulic system	1	31.3.5t
01	H24C7-63021	Hose H.P.	2	
02	Z6051-02804	O-ring	1	GB1235-76
03	B5050-00006	Washer,lock	9	GB93-87
04	B0330-06025	Bolt	2	GB5783-86
05	H24C7-60601	Steel pipe ass'y	1	
06	B0530-10025	Bolt	1	GB5786-86
07	B5310-00010	Washer	10	GB97.1-85
08	B4223-00010	Nut	4	GB6171-86
09	B0330-10040	Bolt	4	GB5783-86
10	B5050-00010	Washer,lock	12	GB93-87
11	Z9501-8a03214	Hose H.P.	2	
12	JT7022-14021	Elbow(Inc.37)	4	
13	JT6021-20021	Nipple(Inc.38)	2	
14	H24C7-60231	Hose	1	二至四片阀 Two to four-throw
-	H24C7-60241	Hose	1	五片阀Five-throw
15	Z4590-00045	Clip	8	
16	JT6022-22061	Elbow(Inc.39)	1	
17	Z9502-13117	Hose H.P.	1	
18	H24C7-60251	Hose	1	
-	H24C7-60261	Hose	1	
-	H24C7-60701	Hose	1	
19	JT7021-10011	Nipple(Inc.02)	1	
20	H24C7-60301	Elbow(Inc.38)	1	
-	H24C7-60221	Elbow(Inc.38)	1	

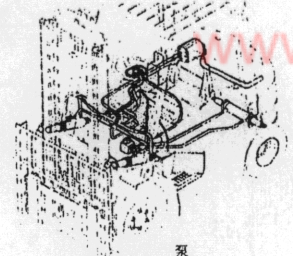
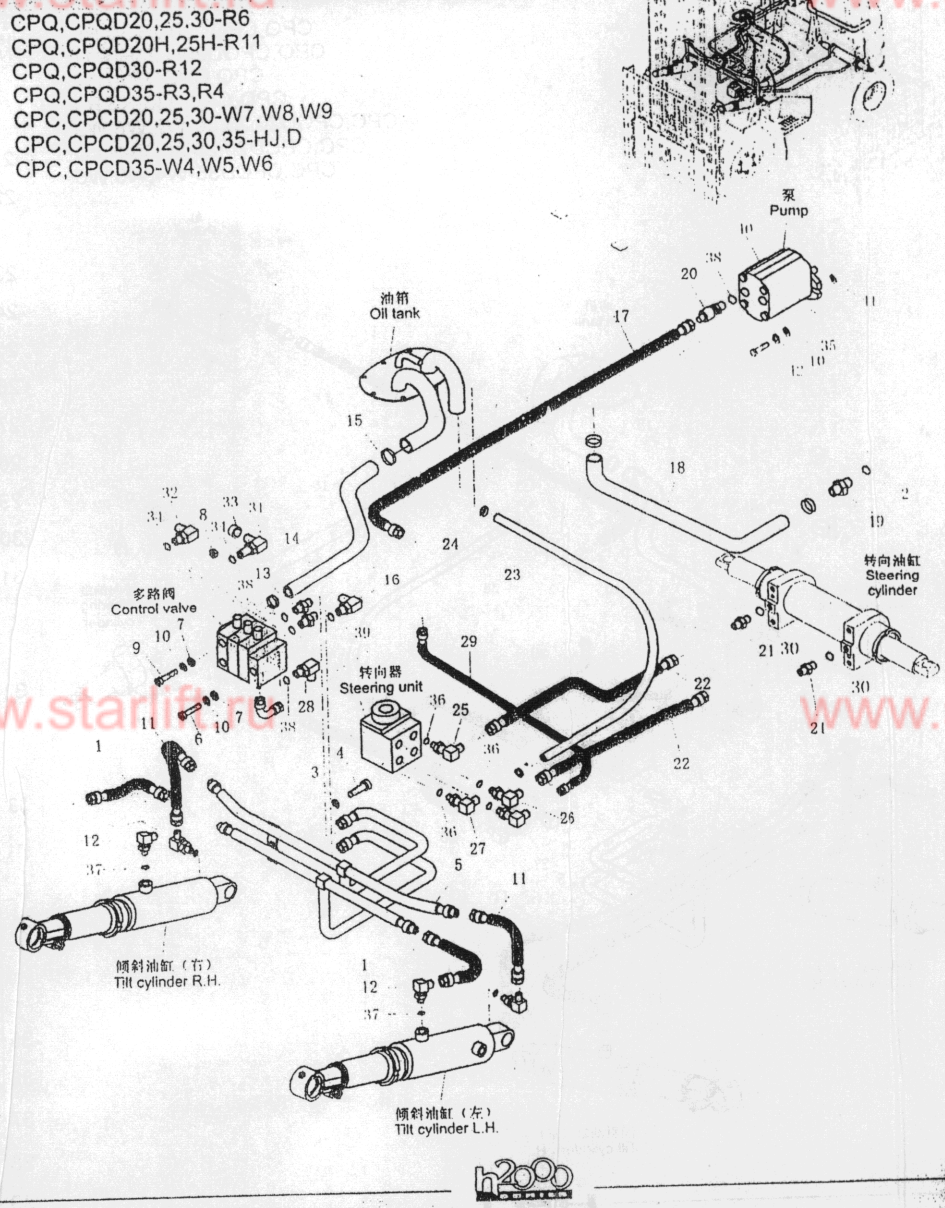

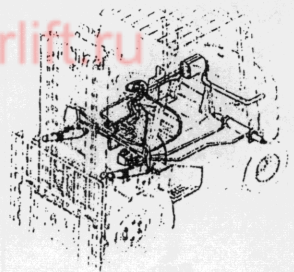

CPQ, CPQD20, 25, 30-R6  
 CPQ, CPQD20H, 25H-R11  
 CPQ, CPQD30-R12  
 CPQ, CPQD35-R3, R4  
 CPC, CPCD20, 25, 30-W7, W8, W9  
 CPC, CPCD20, 25, 30, 35-HJ, D  
 CPC, CPCD35-W4, W5, W6

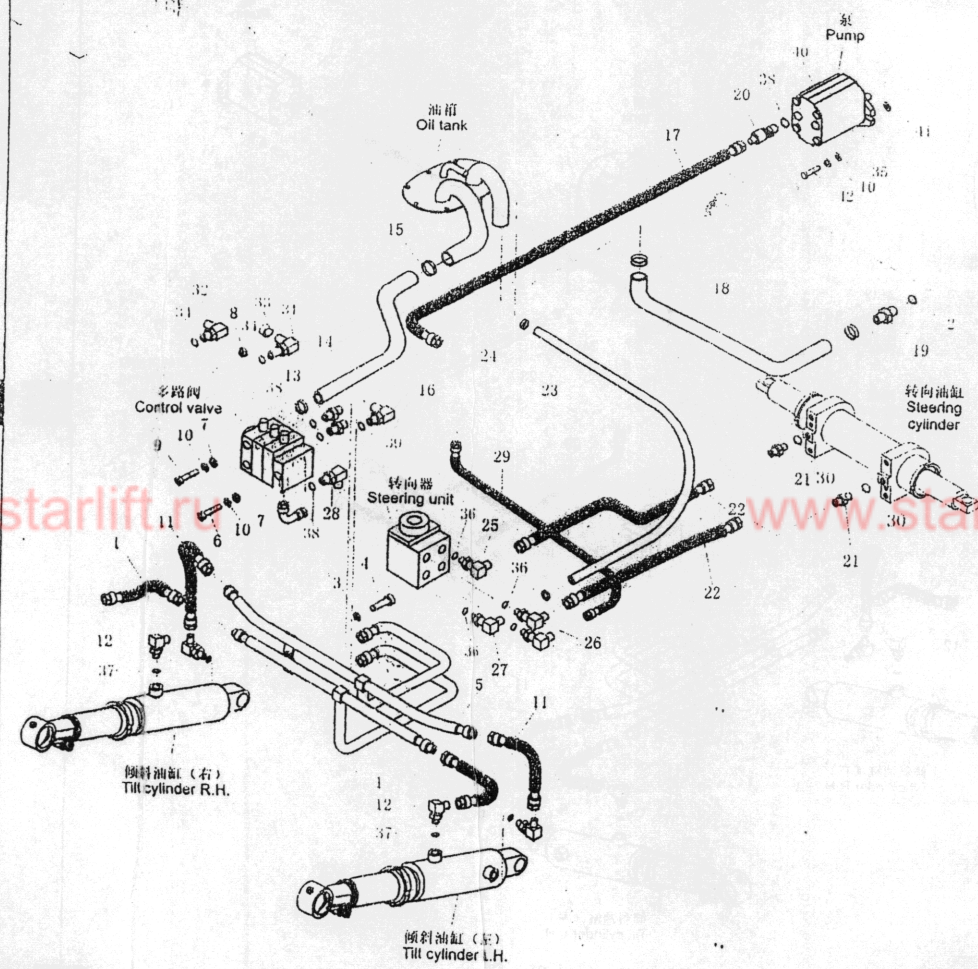

序号 Item No	图号 Part No	零部件名称 Description	件数 Q'ty	备注 Remark
21	JT6025-16071	Nipple(Inc.44)	2	CPC(D)20,25-D,HJ CPC(D)30,35-D,HJ CPC(D)20-30-R6 CPC(D)20-30-W8
22	Z9501-08208	Hose H.P.	2	21,2.5t
-	Z9501-08216	Hose H.P.	2	31,3.5t
23	Z7300-13160	Hose	1	低压胶管φ13X1600
24	Z4503-16025	Clip	2	双钢丝卡箍
25	JT6022-20031	Elbow(Inc.36)	1	直角接头(包括36)
26	JT6022-20051	Elbow(Inc.36)	2	直角接头(包括36)
27	JT6022-22041	Elbow(Inc.36)	1	直角接头(包括36)
28	JT6026-22011	Elbow(Inc.38)	1	直角接头(包括38)
29	A12A7-60401	Hose H.P.	1	高压胶管
30	B5320-00010	Washer	2	垫圈10
31	JT6022-20061	Elbow(Inc.34)	1	直角接头(包括34)
32	JT6022-20071	Elbow(Inc.34)	1	直角接头(包括34)
33	22497-61010	Plug	2	堵头
34	Z6004-01101	Ball	2	O型密封圈11X1.9
35	Z6003-01802	O-ring	2	O型密封圈18X2.4
36	Z6003-02202	O-ring	1	O型密封圈22X2.4
37	Z6003-01502	O-ring	4	O型密封圈15X2.4
38	Z6004-02202	O-ring	8	O型密封圈22X2.4
39	Z6003-02402	O-ring	1	O型密封圈24X2.4

序号 Item No	图号 Part No	零件名称 Description	件数 Qty	备注 Remark
40	HRH24C7101 H24C7-10001	Gear pump	泵 1	CPQ(D)20.25-R6 CPC(D)20-30-W8 CPC(D)20.25-D.HJ
-	HRH24C7101 H24C7-10011	Gear pump	泵 1	CPQ(D)20H.25H-R11 CPQ(D)30-R6.R12 CPC(D)30-D.HJ CPQ(D)35-R3.R4 CPC(D)35-W4.D.HJ
-	HRH24C7101 H25S7-10001	Gear pump	泵 1	CPC(D)20.25-W7.W9
-	HRH24C7101 H25S7-10011	Gear pump	泵 1	CPC(D)30-W7.W9 CPC(D)35-W5.W6
41	23657-12001	Packing	垫 1	柴油机
-	Z6053-08253	O-ring	2	汽油机 GB3452.1-82
42	B0330-10030	Bolt	2	柴油机 GB5783.86
-	B0430-10030	Bolt	2	汽油机 GB5785-86

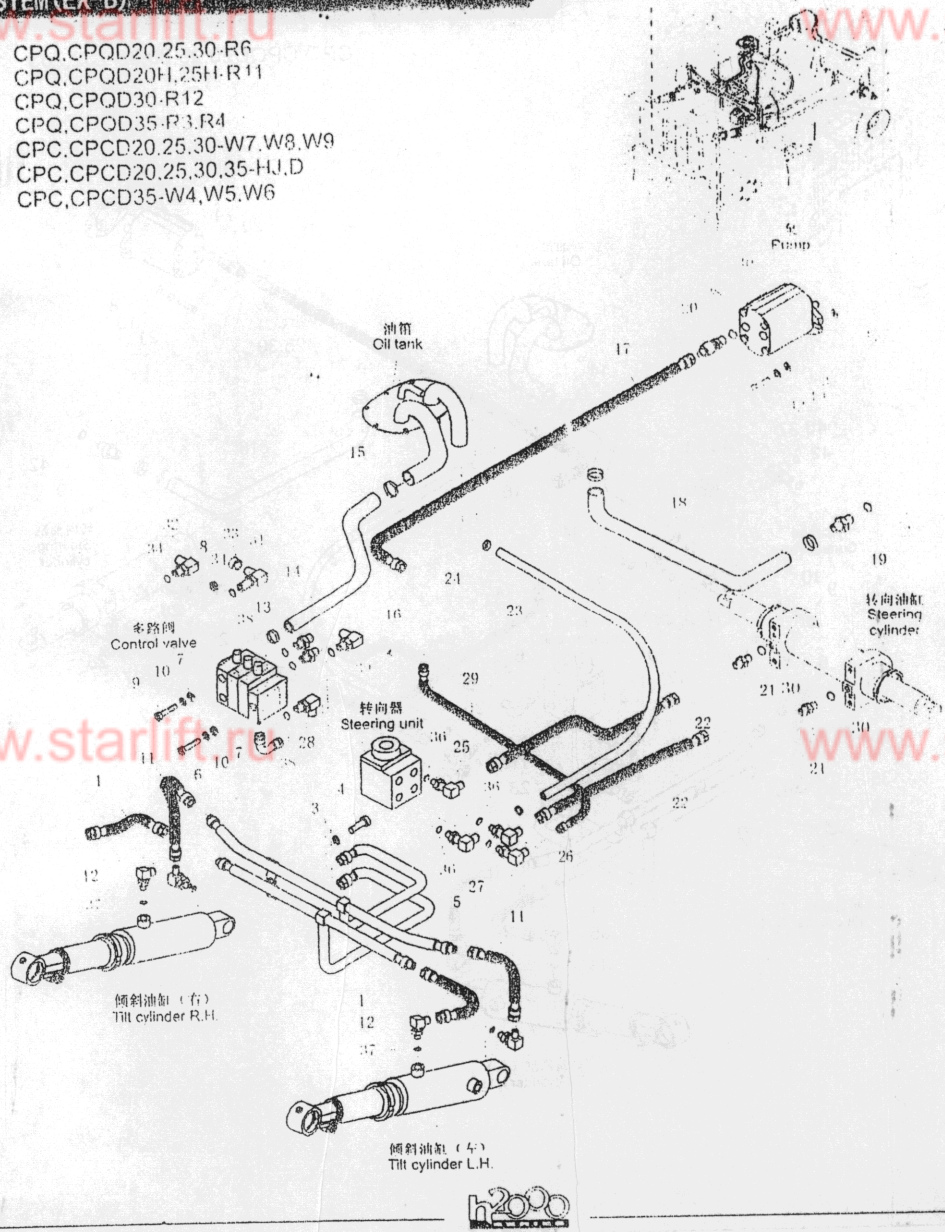

CPQ, CPQD20, 25, 30, 35-ZJ2, ZJ3

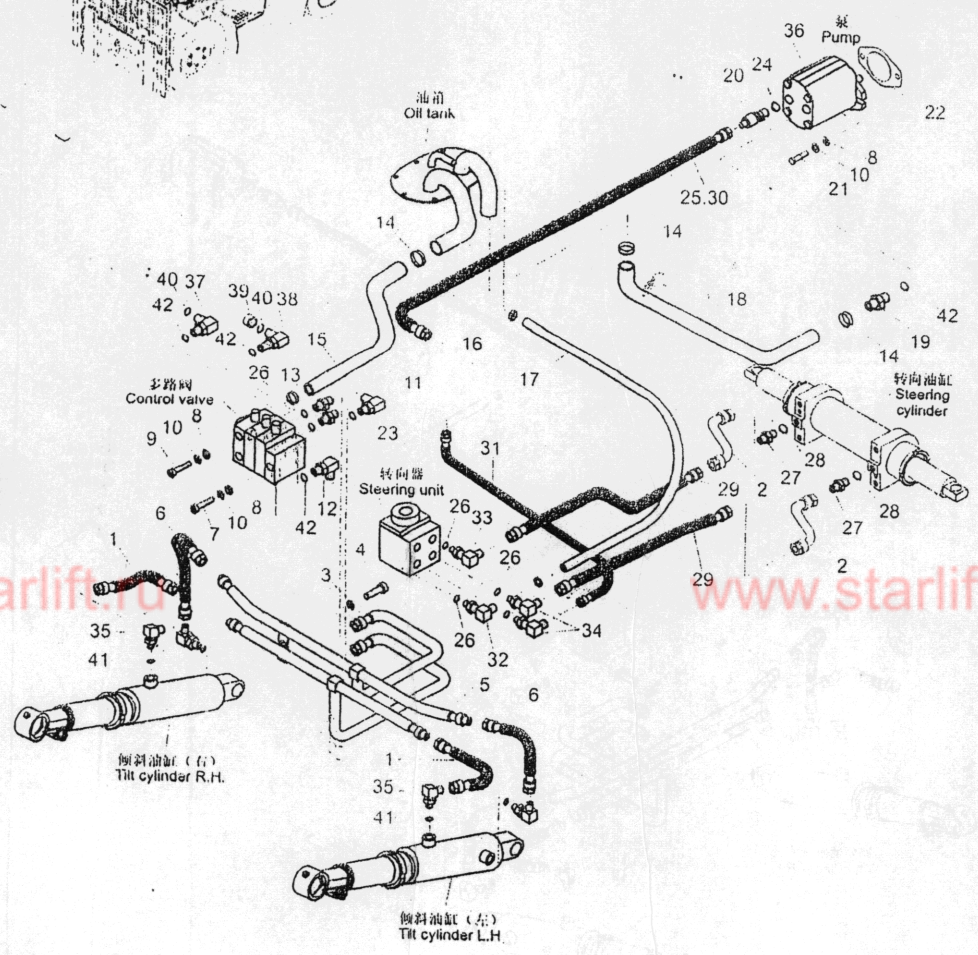

序号 Item No	图号 Part No	零部件名称 Description	件数 Q'ty	备注 Remark
A	H90Z7-60001	Hydraulic system	1	液压管路系统
01	H24C7-63021	Hose H.P.	2	高压胶管
02	H24N7-60201	Steering steel pipe	2	转向缸钢管
03	B5050-00006	Washer, lock	9	垫圈6
04	B0330-06025	Bolt	2	螺栓M6X25
05	H24C7-60601	Steel pipe ass'y	1	倾斜缸钢管总成
06	Z9501-8a03214	Hose H.P.	2	高压胶管
07	B0530-10025	Bolt	1	螺栓M10X1.25X25
08	B5310-00010	Washer	5	垫圈10
09	B0530-10030	Bolt	2	螺栓M10X1.25X30
10	B5050-00010	Washer, lock	5	垫圈10
11	JT6022-22061	Elbow(Inc.23)	1	直角接头(包括23)
12	JT6022-22011	Elbow(Inc.42)	1	直角接头(包括42)
13	JT6021-20021	Nipple(Inc.26)	2	直通接头(包括26)
14	Z4590-00045	Clip	6	双钢丝卡箍∅45
15	H24C7-60231	Hose	1	多路阀回油管
16	H24C7-60241	Hose	1	多路阀回油管
17	Z4590-00022	Clip	2	双钢丝卡箍∅22
18	Z7300-13160	Hose H.P.	1	胶管∅13X1600
19	H90Z7-62001	Hose L.P.	1	吸油管
20	H24C7-60221	Nipple(Inc.42)	1	油泵接头(包括42)
21	H90Z7-60201	Nipple(Inc.24)	1	油泵吸油接头(包括24)
22	B0330-10030	Bolt	2	螺栓M10X30
23	Z3657-12001	Packing	1	垫
24	Z6003-02402	O-ring	1	O型密封圈24X2.4
25	Z6053-02803	O-ring	1	O型密封圈28X3.55
26	Z9502-13122	Hose H.P.	1	高压胶管1311X1220
27	Z6003-02202	O-ring	6	O型密封圈22X2.4
28	JT6021-16201	Nipple(Inc.28)	2	直通接头(包括28)
29	Z6052-01322	O-ring	2	O型密封圈13.2X2.65

G

序号 Item No	图号 Part No	零部件名称 Description	件数 Qty	备注 Remark
29	Z9501-08208	Hose H.P. 高压胶管8IX2080	2	21,2.5t
-	Z9501-08216	Hose H.P. 高压胶管8IX2160	2	3t,3.5t
30	21197-60130	Sleeve,rubber 橡胶套	3	
31	A12A7-60401	Hose H.P. 高压胶管	1	
32	JT6022-22041	Elbow(Inc.26) 直角接头(包括26)	1	
33	JT6022-20031	Elbow(Inc.26) 直角接头(包括26)	1	
34	JT6022-20051	Elbow(Inc.26) 直角接头(包括26)	2	
35	JT7022-14021	Elbow(Inc.41) 直角接头(包括41)	4	
36	H98D7-10001	Gear pump 油泵	1	21,2.5t
-	H90Z7-10001	Gear pump 油泵	1	3t,3.5t
37	JT6022-20061	Elbow(Inc.40,42) 直角接头(包括40,42)	1	三片阀Three-throw
			2	四片阀Four-throw
			3	五片阀Five-throw
38	JT6022-20071	Elbow(Inc.40,42) 直角接头(包括40,42)	1	三片阀Three-throw
			2	四片阀Four-throw
			3	五片阀Five-throw
39	22497-61010	Plug 堵头	2	三片阀Three-throw
			4	四片阀Four-throw
			6	五片阀Five-throw
40	Z6004-01101	O-ring 0型密封圈11X1.9	2	GB1235-76
			4	GB1235-76
41	Z6003-01502	O-ring 0型密封圈15X2.4	4	GB1235-76
42	Z6004-02202	O-ring 0型密封圈22X2.4	2	GB1235-76
			4	GB1235-76
			6	GB1235-76
			8	GB1235-76

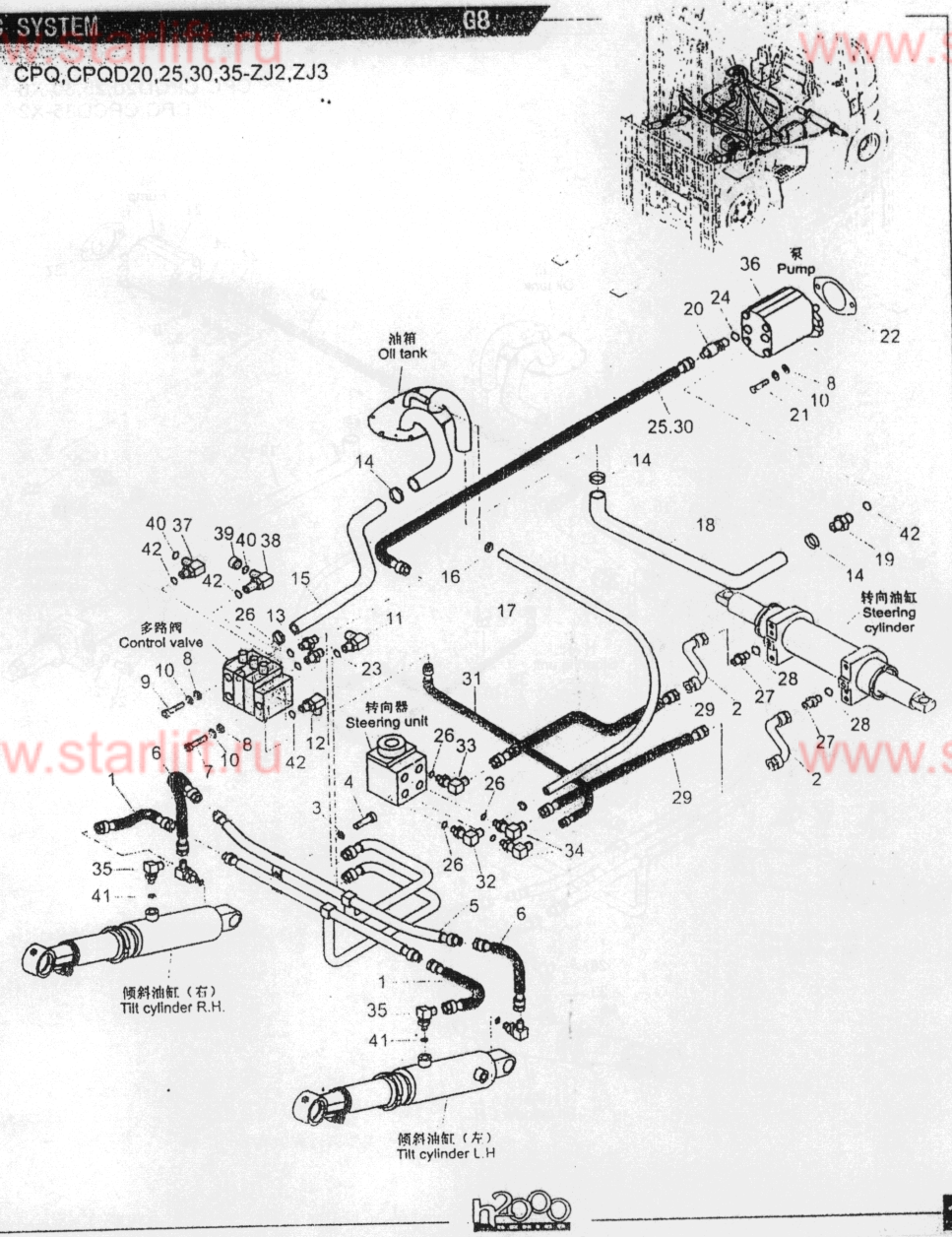



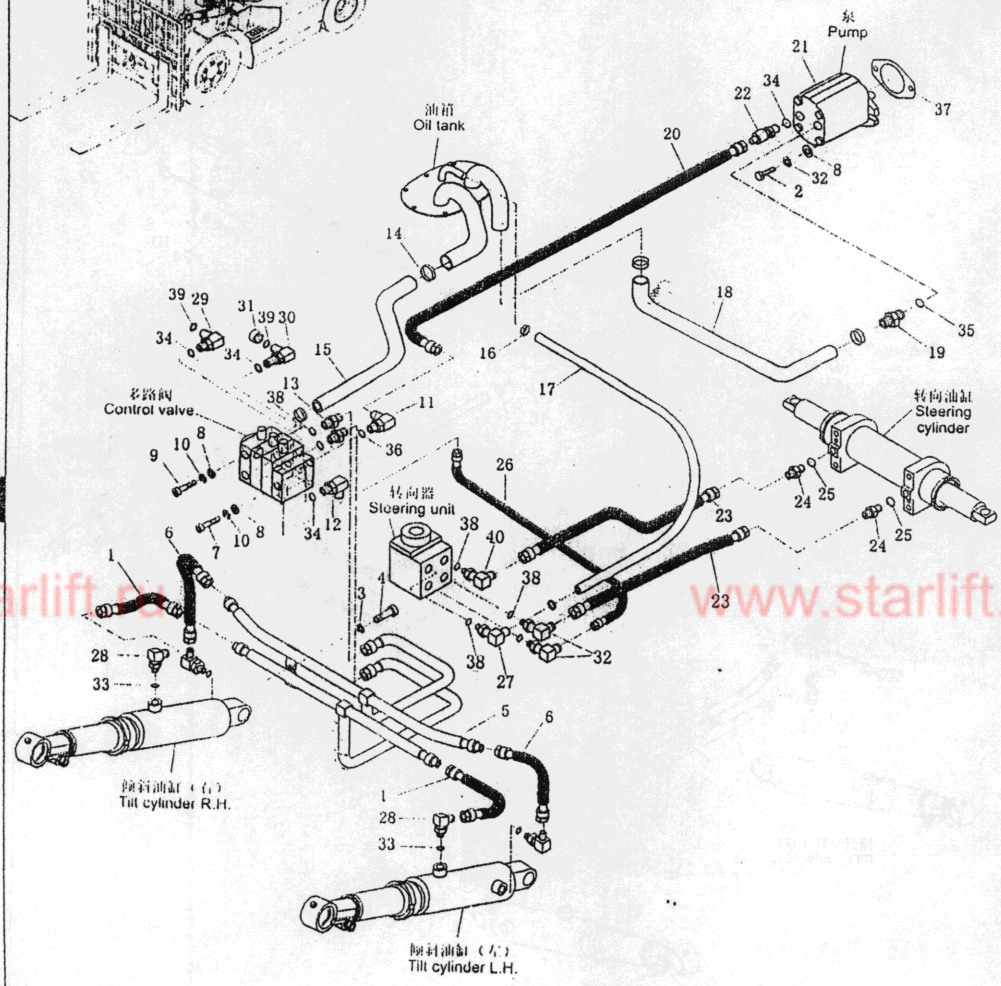
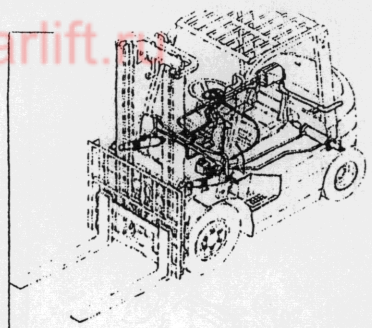

CPC,CPCD20,25,30-X6  
CPC,CPCD35-X2

序号 Item No	图号 Part No	零部件名称 Description	件数 Q'ty	备注 Remark
A	HRH93C7601	Hydraulic system	1	21,2.5t
	H93C7-60001	液压管路系统	1	
	HRH93C7601	Hydraulic system	1	31,3.5t
	H93N7-60001	液压管路系统	1	
01	H24C7-63021	Hose H.P.	2	高压胶管总成
02	B0330-10030	Bolt	2	螺栓M10X30
03	B5050-00006	Washer,lock	9	垫圈6
04	B0330-06025	Bolt	2	螺栓M6X25
05	H24C7-60601	Steel pipe ass'y	1	倾斜缸钢管总成
06	Z9501-8a03614	Hose H.P.	2	高压胶管(玛努利管)
07	B0530-10Q25	Bolt	1	螺栓M10X1.25X25
08	B5310-00010	Washer	5	垫圈10
09	B0530-10030	Bolt	2	螺栓M10X1.25X30
10	B5050-00010	Washer,lock	5	垫圈10
11	JT6022-22061	Elbow(Inc.36)	1	直角接头(包括36)
12	JT6026-22011	Elbow(Inc.34)	1	直角接头(包括34)
13	JT6021-20021	Nipple(Inc.38)	2	直通接头(包括38)
14	Z4590-00045	Clip	6	双钢丝卡箍∅45
15	H24C7-60231	Hose	1	多路阀回油管
	H24C7-60241	Hose	1	多路阀回油管
16	Z4590-00022	Clip	2	双钢丝卡箍∅22
17	Z7300-13160	Hose L.P.	1	低压胶管∅13X1600
18	H93C7-62021	Hose	1	吸油管
19	JT7021-10011	Elbow(Inc.35)	1	直角接头(包括35)
20	HRA22A7603*117	Hose H.P.	1	高压胶管811X1170
21	H93C7-10001	Pump	1	泵
	H93N7-10001	Pump	1	泵
22	H24C7-60301	Elbow(Inc.34)	1	油泵接头(包括34)
23	HRA20A7652*208	Hose H.P.	2	高压胶管81X2080
	HRA20A7652*216	Hose H.P.	2	高压胶管81X2160
24	JT6025-16071	Nipple	2	直角接头体
25	Z6003-01802	O-ring	2	O型密封圈18X2.4

G

序号 Item No	图号 Part No	零件名称 Description	件数 Q'ty	备注 Remark
26	A12A7-60401	Hose H.P. 高压胶管	1	
27	JT6022-22041	Elbow(Inc.38) 直角接头(包括38)	1	
28	JT7022-14021	Elbow(Inc.33) 直角接头(包括33)	4	
29	JT6022-20061	Elbow(Inc.34,39) 直角接头(包括34, 39)	1	三片阀Three-throw
			2	四片阀Four-throw
			3	五片阀Five-throw
30	JT6022-20071	Elbow(Inc.34,39) 直角接头(包括34,39)	1	三片阀Three-throw
			2	四片阀Four-throw
			3	五片阀Five-throw
31	22497-61010	Plug 堵头	2	三片阀Three-throw
			4	四片阀Four-throw
			6	五片阀Five-throw
32	JT6022-20051	Elbow(Inc.38) 直角接头(包括38)	2	
33	Z6003-01502	O-ring 0型密封圈15X2.4	4	GB1235-76
34	Z6004-02202	O-ring 0型密封圈22X2.4	2	GB1235-76
			4	二片阀Two-throw
			4	GB1235-76
			6	三片阀Three-throw
			6	GB1235-76
			8	四片阀Four-throw
			8	GB1235-76
			8	五片阀Five-throw
35	Z6051-02804	O-ring 0型密封圈28X3.55	1	GB3452.1-92
36	Z6003-02402	O-ring 0型密封圈24X2.4	1	GB1235-76
37	23657-12001	Packing 垫	1	
38	Z6003-02202	O-ring 0型密封圈22X2.4	6	GB1235-76
39	Z6004-01101	O-ring 0型密封圈11X1.9	2	GB1235-76
			4	三片阀Three-throw
			4	GB1235-76
			6	四片阀Four-throw
			6	GB1235-76
			6	五片阀Five-throw
40	JT6022-20031	Elbow(Inc.38) 直角接头(包括38)	1	

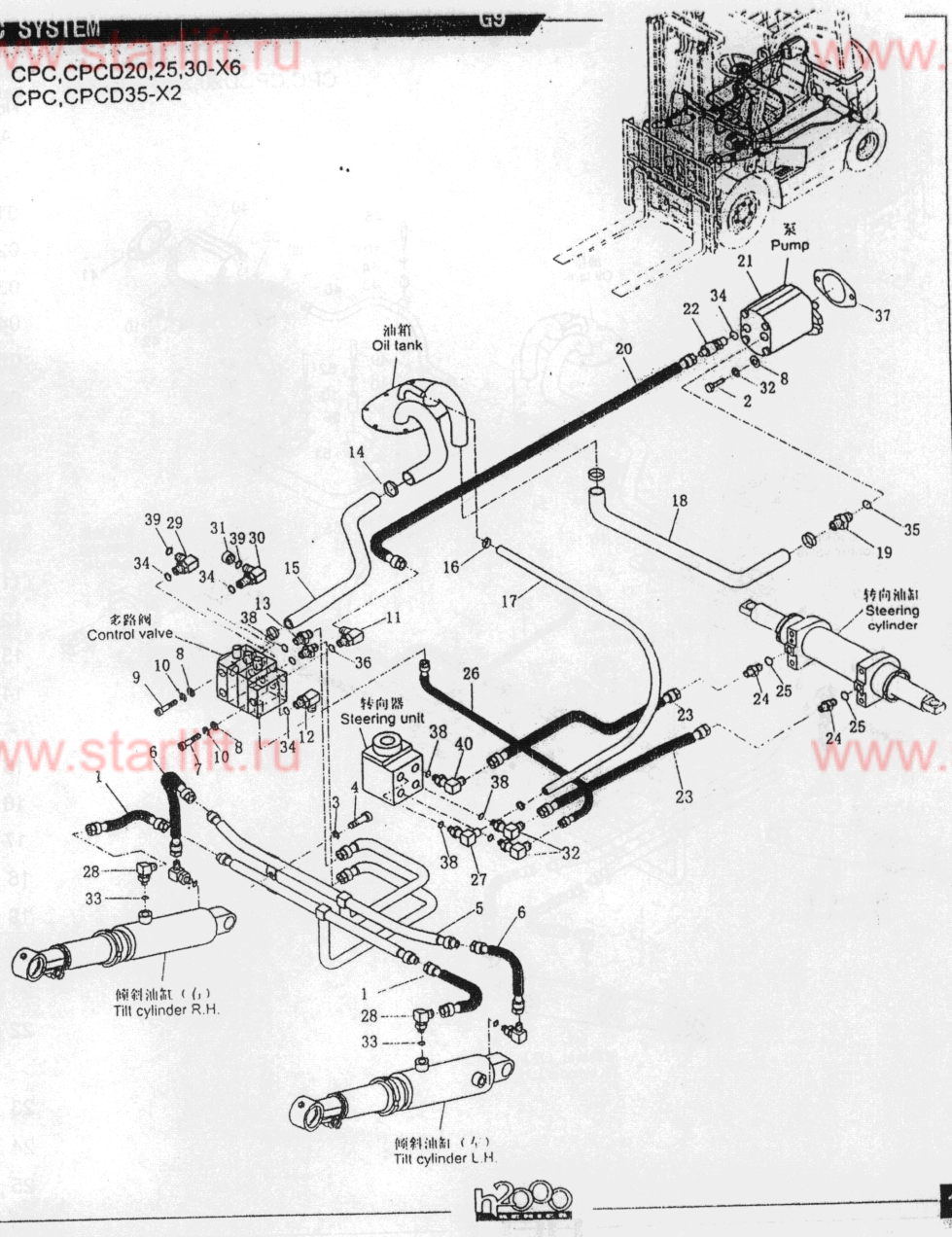

CPC, CPCD20, 25, 30, 35-Xs1

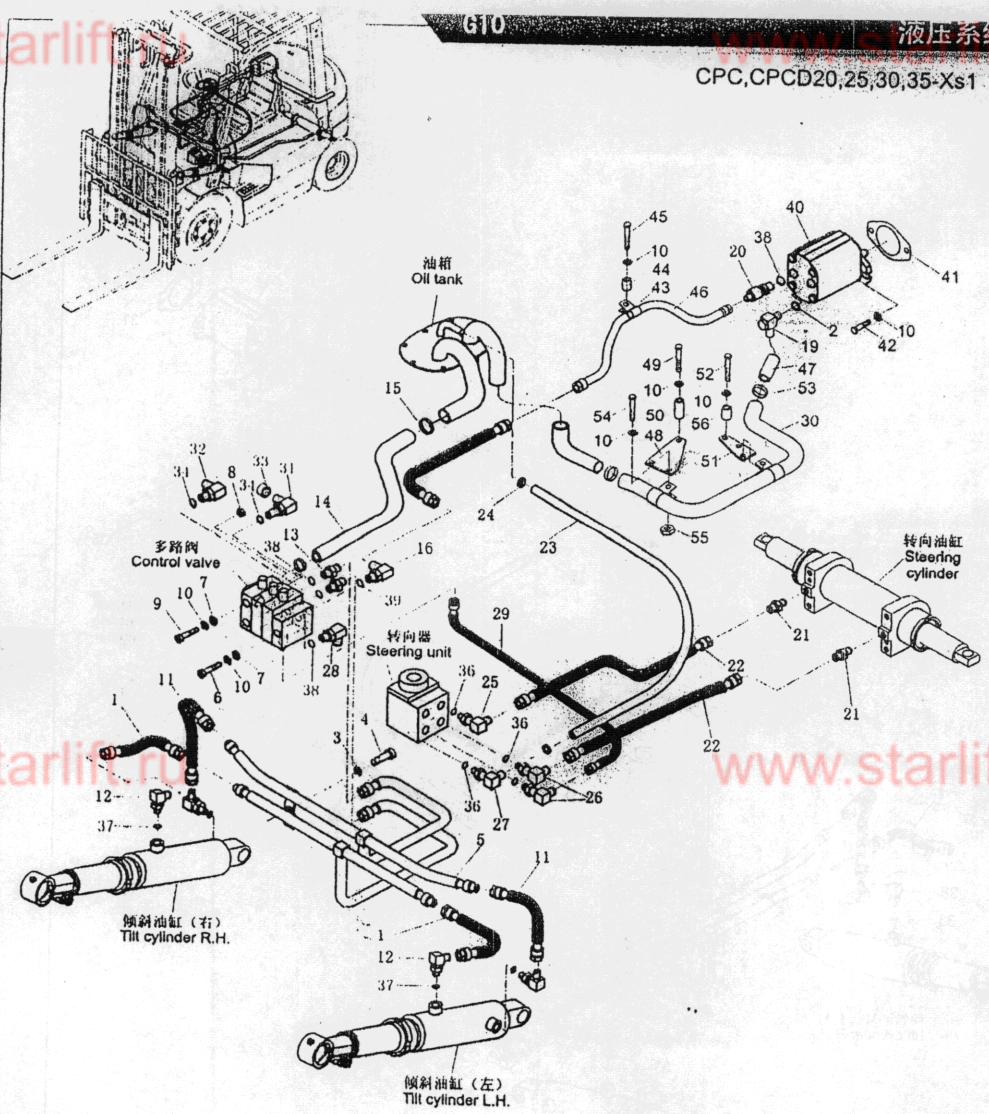

序号 Item No	图号 Part No	零部件名称 Description	件数 Q'ty	备注 Remark
A	HRH2A17601	Hydraulic system	1	21, 2.5t
	H2A17-60001	Hydraulic system	1	31, 3.5t
	HRH2A17601	Hydraulic system	1	31, 3.5t
	H2F17-60001	Hydraulic system	1	31, 3.5t
01	H24C7-63021	Hose H.P.	2	高压胶管
02	Z6053-02803	O-ring	1	O型密封圈
03	B5050-00006	Washer, lock	9	垫圈6
04	B0330-06025	Bolt	2	螺栓M6X25
05	H24C7-60601	Steel pipe ass'y	1	倾斜缸钢管总成
06	B0530-10025	Bolt	1	螺栓M10X1.25X25
07	B5310-00010	Washer	10	垫圈10
08	B4223-00010	Nut	4	螺母M10
09	B0330-10040	Bolt	4	螺栓M10X40
10	B5050-00010	Washer, lock	12	垫圈10
11	Z9501-8a03214	Hose H.P.	2	高压胶管
12	JT7022-14021	Elbow(Inc.37)	4	直角接头(包括37)
13	JT6021-20021	Nipple(Inc.36)	2	直通接头(包括36)
14	H24C7-60231	Hose	1	多路阀回油管
	H24C7-60241	Hose	1	多路阀回油管
15	Z4590-00045	Clip	8	双钢丝卡箍∅45
16	JT6022-22061	Elbow(Inc.39)	1	直角接头(包括39)
17	Z9502-13082	Hose H.P.	1	高压胶管
18	H21U7-62001	Hose	1	吸油管
19	JT7022-10031	Elbow(Inc.02)	1	直角接头(包含02)
20	JT7021-12051	Nipple(Inc.36)	1	直通接头(包含36)
21	JT6025-16071	Nipple	2	直通接头
22	Z9501-08208	Hose H.P.	2	高压胶管
	Z9501-08216	Hose H.P.	2	高压胶管
23	Z7300-13160	Hose	1	
24	Z4503-16025	Clip	2	双钢丝卡箍
25	JT6022-20031	Elbow(Inc.36)	1	直角接头(包含36)
26	JT6022-20051	Elbow(Inc.36)	2	直角接头(包含36)

序号 Item No	图号 Part No	零部件名称 Description	件数 Q'ty	备注 Remark
27	JT6022-22041	Elbow(Inc.36) 直角接头(包括36)	1	
28	JT6022-22011	Elbow(Inc.38) 直角接头(包括38)	1	
29	A12A7-60401	Hose H.P. 高压胶管	1	
30	H2A17-62001	Steel pipe 吸油钢管	1	
31	JT6022-20061	Elbow(Inc.34,38) 直角接头(包含34,38)	1	三片阀Three-throw
-	-	-	2	四片阀Four-throw
-	-	-	3	五片阀Five-three
32	JT6022-20071	Elbow(Inc.34,38) 直角接头(包含34,38)	1	三片阀Three-throw
-	-	-	2	四片阀Four-throw
-	-	-	3	五片阀Five-three
33	22497-61010	Plug 堵头	2	三片阀Three-throw
-	-	-	4	四片阀Four-throw
-	-	-	6	五片阀Five-three
34	Z6004-01101	Ball 0型密封圈11X1.9	2	三片阀Three-throw GB1235-76
-	-	-	4	四片阀Three-throw GB1235-76
-	-	-	6	五片阀Three-throw GB1235-76
35	Z6003-01802	O-ring 0型密封圈18X2.4	2	GB1235-76
36	Z6003-02202	O-ring 0型密封圈22X2.4	1	GB1235-76
37	Z6003-01502	O-ring 0型密封圈15X2.4	4	GB1235-76
38	Z6004-02202	O-ring 0型密封圈22X2.4	8	GB1235-76
39	Z6003-02402	O-ring 0型密封圈22X2.4	1	GB1235-76
40	HRH24C7101 H25S7-10001	Gear pump 齿轮油泵	1	2,2.5t
-	HRH24C7101 H25S7-10011	Gear pump 齿轮油泵	1	3,3.5t
41	23657-12001	Packing 垫	1	
42	B0330-10030	Bolt 螺栓M10X30	2	GB5783-86
43	H2A17-62111	Clip 卡箍	2	
44	H2A17-62101	Block 垫块(三)	2	
45	B0230-10045	Bolt 螺栓M10X45	2	GB5782-86
46	H2A17-60201	Steel pipe ass'y,output 出油钢管总成	1	
47	Z7353-32070	Hose 胶管∅32X70	1	

CPC, CPCD20, 25, 30, 35-Xs1

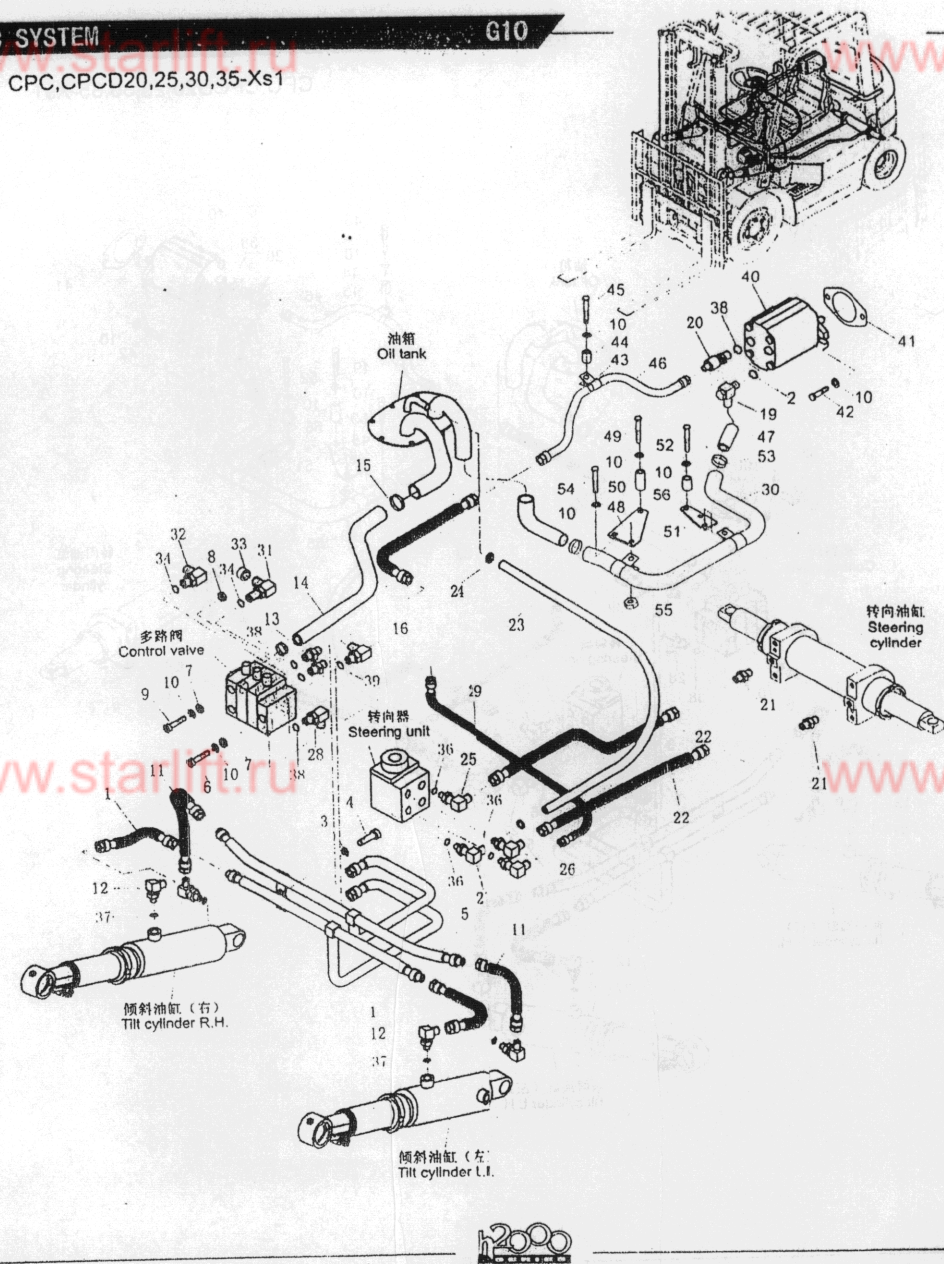

CPC, CPCD20, 25, 30, 35-Xs1

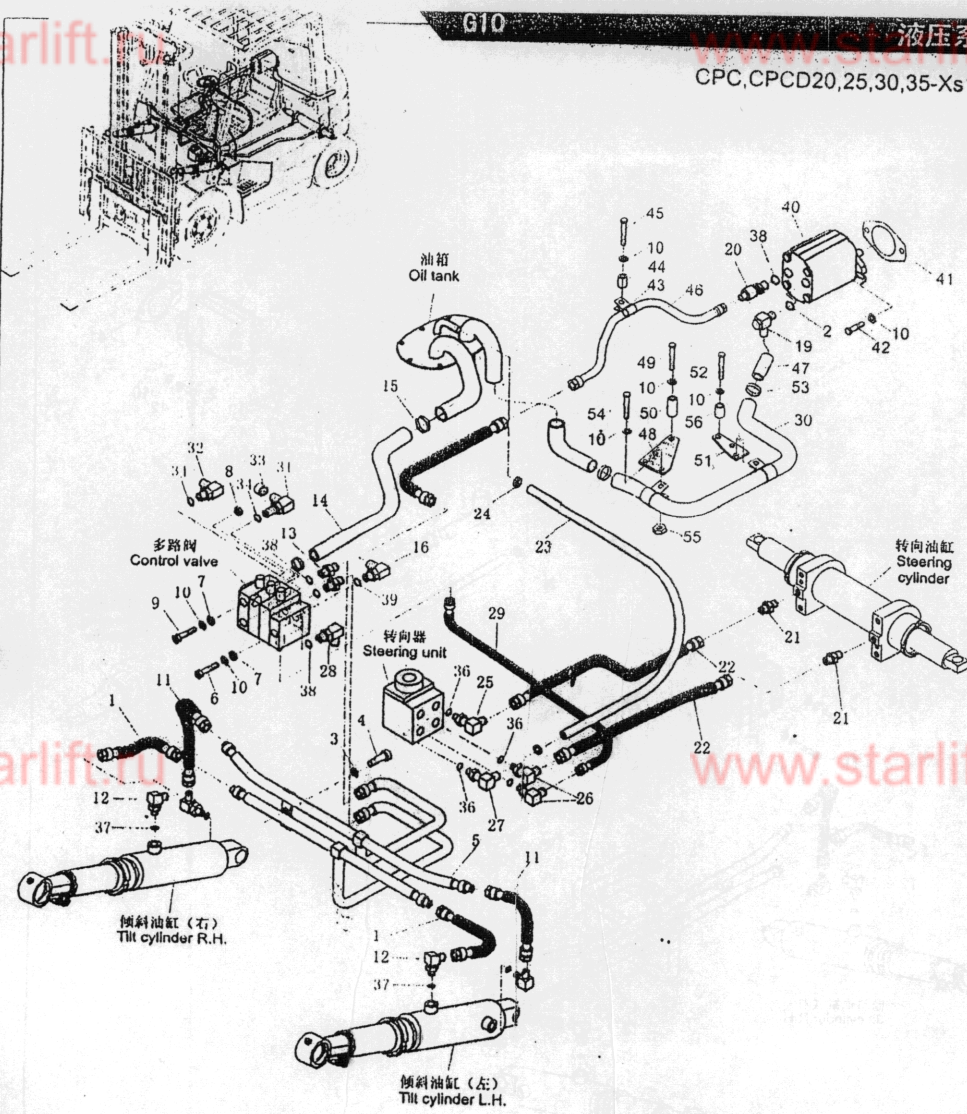

序号 Item No	图号 Part No	零部件名称 Description	件数 Q'ty	备注 Remark
48	H2A17-62061	Plate	板(二) 1	
49	B0230-10070	Bolt	螺栓M10X70 2	GB5782-86
50	H2A17-62071	Block	垫块(二) 2	
51	H2A17-62011	Plate	板(一) 1	
52	B0230-10050	Bolt	螺栓M10X50 2	GB5782-86
53	H2A17-62051	Clip	卡箍 2	
54	B0330-10020	Bolt	螺栓M10X20 2	GB5783-86
55	B4116-00010	Nut	螺母M10 4	GB6170-86
56	H2A17-62031	Block	垫块 2	

G

序号 Item No	图号 Part No	零部件名称 Description	件数 Q'ty	备注 Remark
A	HRH2B97601 H2F97-60001	Hydraulic system	1	2t
-	HRH2B97601 H2F97-60001	Hydraulic system	1	2.5t
-	HRH2B97601 H2F97-60001	Hydraulic system	1	3t
01	H24C7-63021	Hose H.P.	1	
02	Z6051-02804	O-ring	2	GB1235-76
03	B5050-00006	Washer,lock	9	GB93-87
04	B0330-06025	Bolt	2	GB5783-86
05	H24C7-60601	Steel pipe ass'y	1	
06	B0530-10025	Bolt	1	GB5786-86
07	B5310-00010	Washer	10	GB97.1-85
08	B4223-00010	Nut	4	GB6171-86
09	B0330-10040	Bolt	4	GB5783-86
10	B5050-00010	Washer,lock	10	GB93-87
11	Z9501-8a03614	Hose H.P.	2	
12	JT7022-14021	Elbow(Inc.37)	4	
13	JT6021-20021	Nipple(Inc.38)	2	
14	H24C7-60231	Hose	1	二至四片阀 Two to four-throw
-	H24C7-60241	Hose	1	五片阀Five-throw
15	Z4590-00045	Clip	8	
16	JT6022-22061	Elbow(Inc.39)	1	
17	Z9502-13117	Hose H.P.	1	
18	H2B97-62004	Hose	1	
19	JT7021-10011	Nipple(Inc.02)	1	
20	H24C7-60221	Elbow(Inc.38)	1	
21	JT6025-16071	Nipple	2	
22	Z9501-08208	Hose H.P.	2	21.2.5t
-	Z9501-08216	Hose H.P.	2	3t
23	Z7300-13160	Hose H.P.	1	
24	Z4503-16025	Clip	2	
25	JT6022-20031	Elbow(Inc.36)	1	

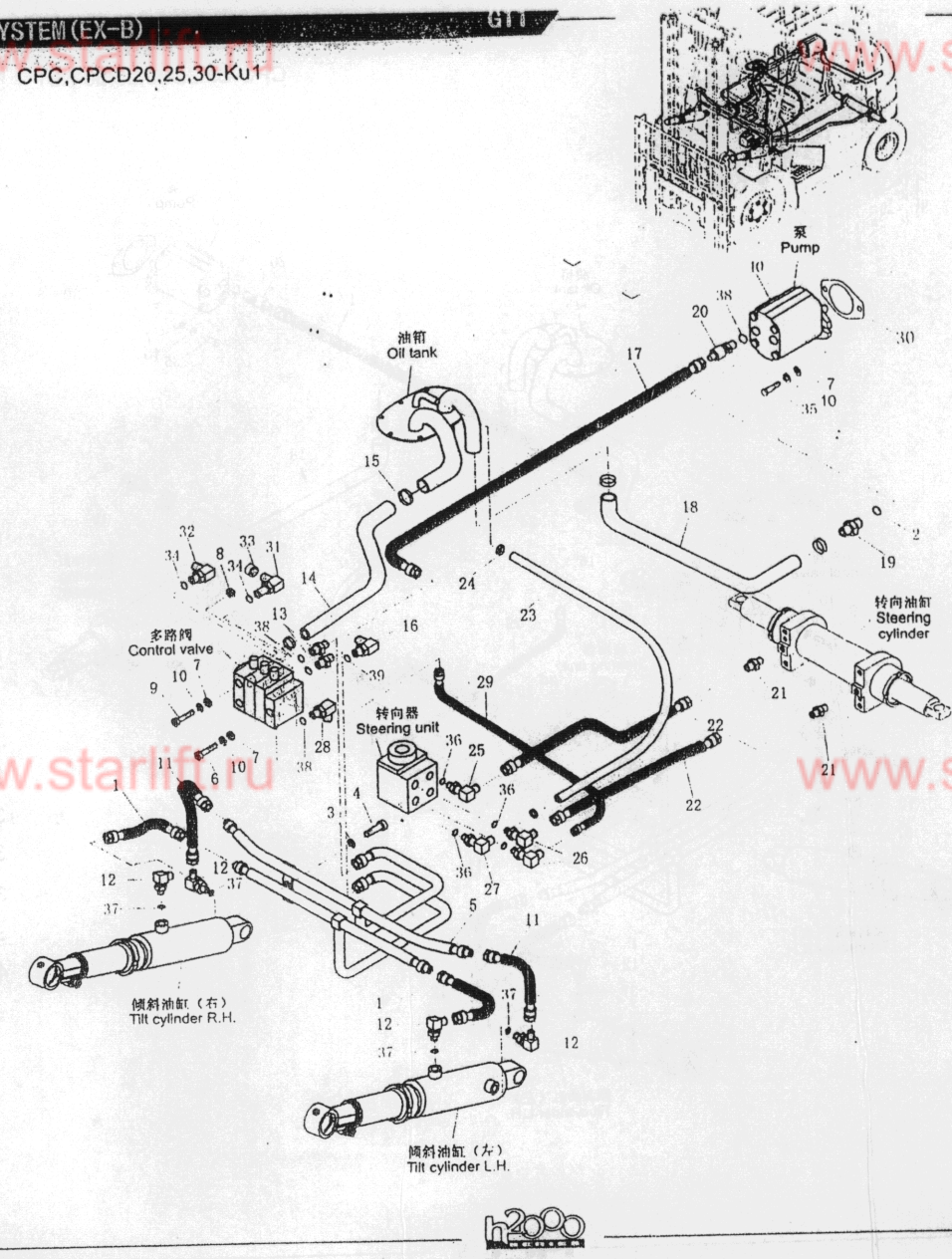

CPC, CPCD20, 25, 30-Ku1

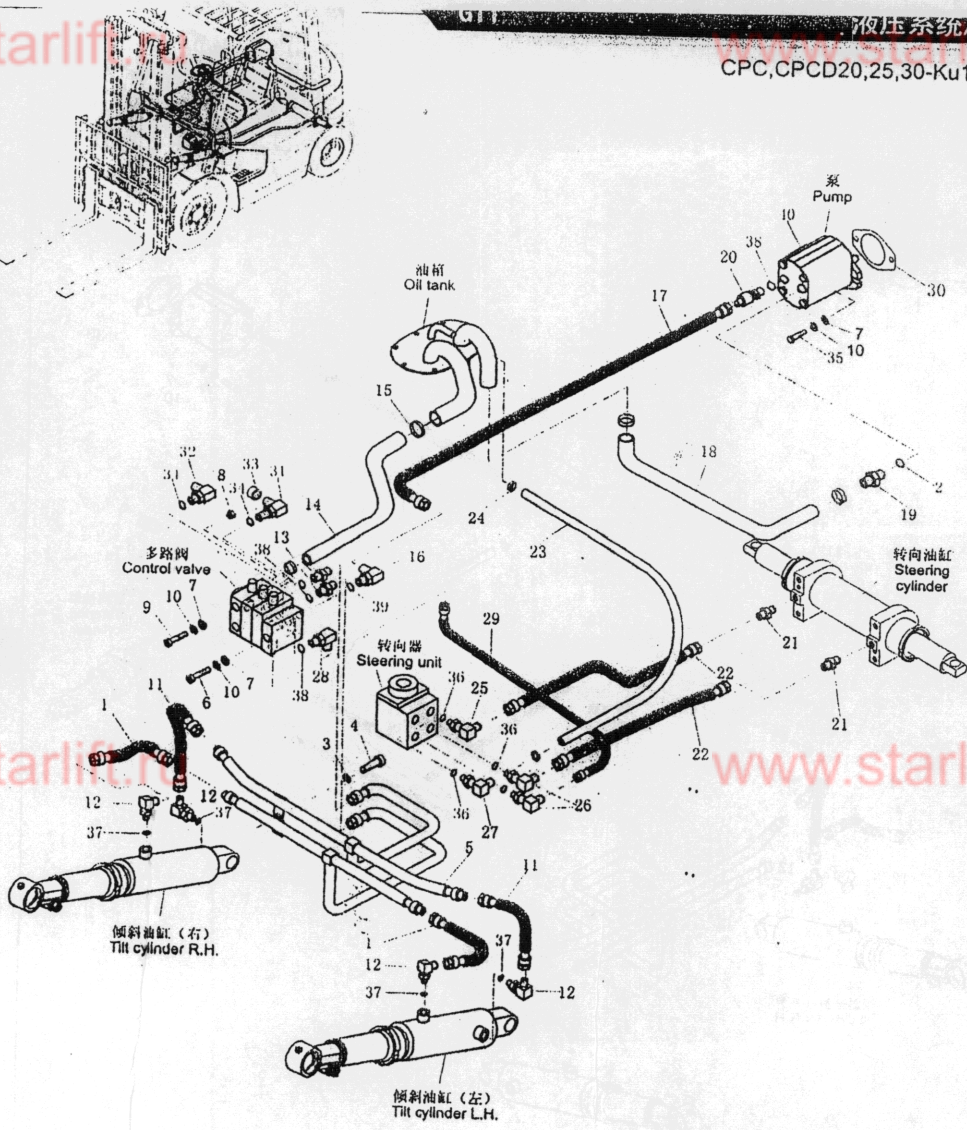

序号 Item No	图号 Part No	零件名称 Description	件数 Q'ty	备注 Remark
26	JT6022-20051	Elbow(Inc.36) 直角接头 (包括36)	2	
27	JT6022-22041	Elbow(Inc.36) 直角接头 (包括36)	1	
28	JT6022-22011	Elbow(Inc.38) 直通接头 (包括38)	1	
29	A12A7-60401	Hose H.P. 高压胶管	1	
30	23657-12001	Packing 垫	2	
31	JT6022-20061	Elbow(Inc.34) 直角接头 (包括34)	1	三片阀 Three-throw
			2	四片阀 Four-throw
			3	五片阀 Five-throw
32	JT6022-20071	Elbow(Inc.34) 直角接头 (包括34)	1	三片阀 Three-throw
			2	四片阀 Four-throw
			3	五片阀 Five-throw
33	22497-61010	Plug 堵头	2	三片阀 Three-throw
			4	四片阀 Four-throw
			6	五片阀 Five-throw
34	Z6004-01101	O-ring 0型密封圈 11X1.9	2	三片阀 Three-throw GB1235-76
			4	四片阀 Three-throw GB1235-76
			6	五片阀 Three-throw GB1235-76
35	B0430-10110	Bolt 螺栓 M10X1.25X110	2	GB5785-86
36	Z6003-02202	O-ring 0型密封圈 22X2.4	4	GB1235-76
37	Z6003-01502	O-ring 0型密封圈 15X2.4	4	GB1235-76
38	Z6004-02202	O-ring 0型密封圈 22X2.4	4	GB1235-76
39	Z6003-02402	O-ring 0型密封圈 24X2.4	1	GB1235-76
40	H14S7-10001	Gear pump 泵	1	2L2.5t
-	H2F97-10001	Gear pump 泵	1	3t

序号 Item No	图号 Part No	零部件名称 Description	件数 Q'ty	备注 Remark
A	HRE2B97601 E2B97-60001	Hydraulic system	1	2t
-	HRE2B97601 E2D97-60001	Hydraulic system	1	2.5t
-	HRE2B97601 E2F97-60001	Hydraulic system	1	3t
01	E24C7-60271	Hose H.P.	1	高压胶管总成
02	Z6051-02804	O-ring	2	O型密封圈28X3.55
03	B5050-00006	Washer,lock	9	垫圈6
04	B0330-06025	Bolt	2	螺栓M6X25
05	E24C7-60231	Steel pipe ass'y	1	倾斜缸钢管总成
06	B0530-10025	Bolt	1	螺栓M10X1.25X25
07	B5310-00010	Washer	10	垫圈10
08	B4223-00010	Nut	4	螺母M10X1.25
09	B0330-10040	Bolt	4	螺栓M10X40
10	B5050-00010	Washer,lock	10	垫圈10
11	Z7801-8a03614	Hose H.P.	2	高压胶管
12	JT8022-96051	Elbow(Inc.37)	4	直角接头(包括37)
13	JT6021-20021	Nipple(Inc.38)	2	直通接头(包括38)
14	H24C7-60231	Hose	1	多路阀回油管
-	H24C7-60241	Hose	1	多路阀回油管
15	Z4590-00045	Clip	8	双钢丝卡箍Ø45
16	JT8022-34011	Elbow(Inc.36)	1	直角接头(包括36)
17	Z7802-13117	Hose H.P.	1	高压胶管130X1170
18	H2B97-62004	Hose	1	吸油管
19	JT7021-10011	Nipple(Inc.02)	1	直通接头(包括02)
20	E24C7-60321	Elbow(Inc.38)	1	油泵接头(包括38)
21	JT8025-96031	Nipple	2	直通接头体
22	Z7801-08208	Hose H.P.	2	高压胶管
-	Z7801-08216	Hose H.P.	2	高压胶管
23	Z7300-13160	Hose H.P.	1	低压胶管Ø13X1600
24	Z4503-16025	Clip	2	喉箍16-25
25	JT8022-96041	Elbow(Inc.36)	1	直角接头(包括36)

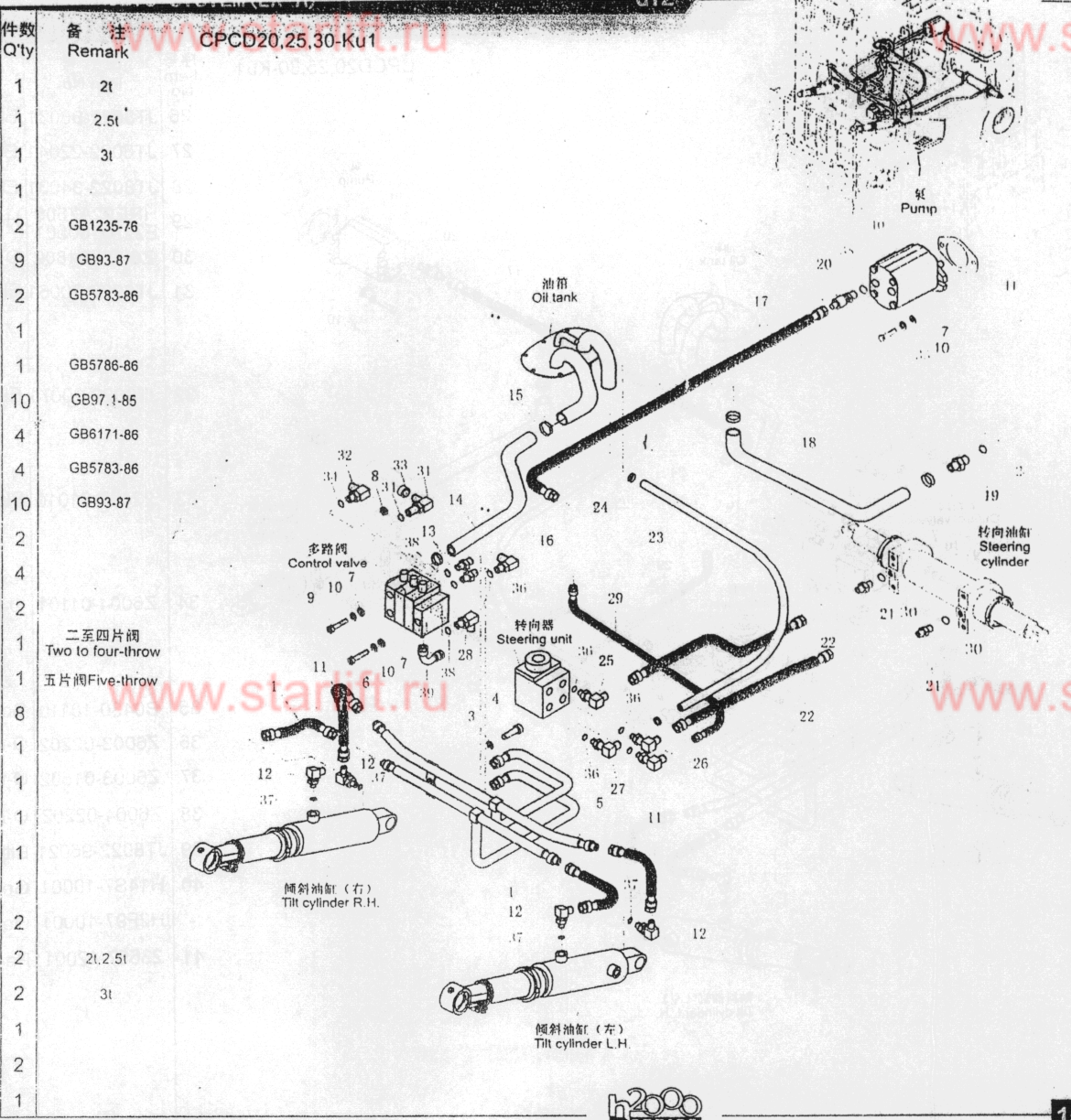



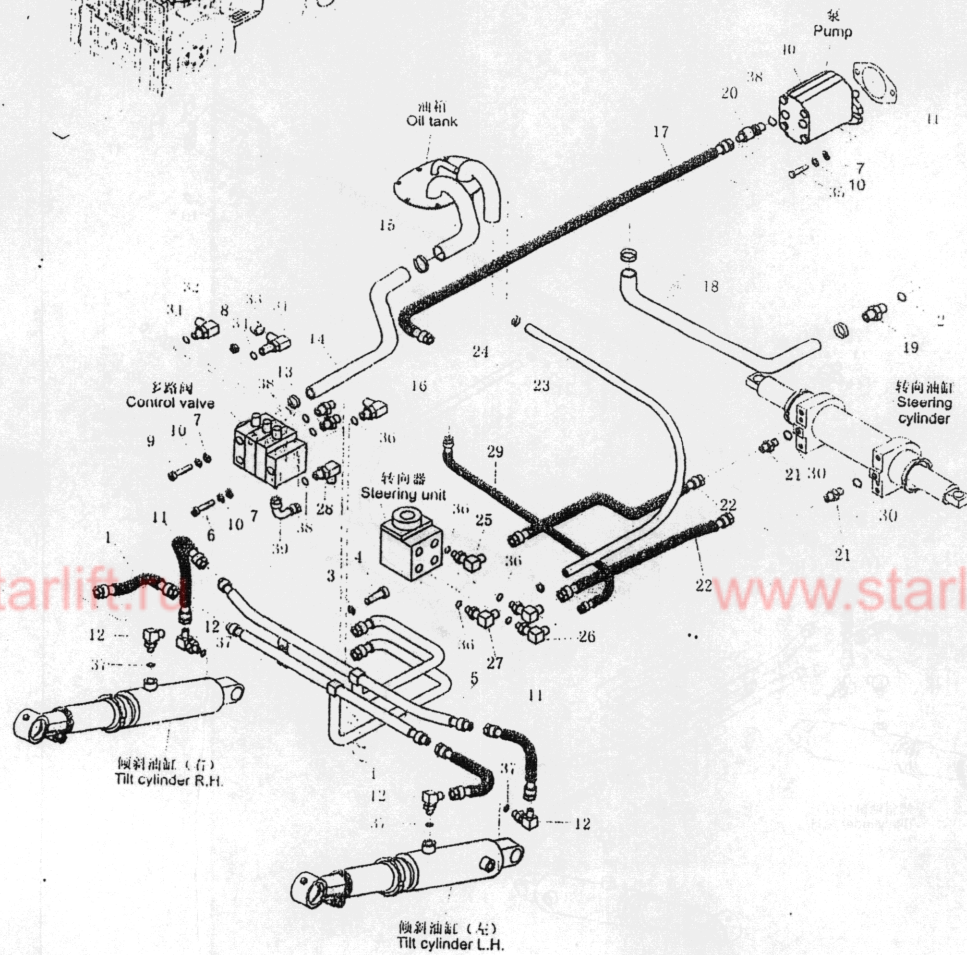

CPCD20,25,30-Ku1

序号 Item No	图号 Part No	零件名称 Description	件数 Qty	备注 Remark
26	JT8022-96031	Elbow(Inc.36) 直角接头(包括36)	2	
27	JT6022-22041	Elbow(Inc.36) 直角接头(包括36)	1	
28	JT8022-34031	Elbow(Inc.38) 直通接头(包括38)	1	
29	HRE22A7605 E22A7-60501	Hose H.P. 高压胶管	1	
30	Z6003-01802	O-ring 0型密封圈18X2.4	2	GB1235-76
31	JT6022-20061	Elbow(Inc.34) 直角接头(包括34)	1	三片阀Three-throw
			2	四片阀Four-throw
			3	五片阀Five-throw
32	JT6022-20071	Elbow(Inc.34) 直角接头(包括34)	1	三片阀Three-throw
			2	四片阀Four-throw
			3	五片阀Five-throw
33	22497-61010	Plug 堵头	2	三片阀Three-throw
			4	四片阀Four-throw
			6	五片阀Five-throw
34	Z6004-01101	O-ring 0型密封圈11X1.9	2	三片阀Three-throw GB1235-76
			4	四片阀Three-throw GB1235-76
			6	五片阀Three-throw GB1235-76
35	B0430-10110	Bolt 螺栓M10X1.25X110	2	GB5785-86
36	Z6003-02202	O-ring 0型密封圈22X2.4	5	GB1235-76
37	Z6003-01502	O-ring 0型密封圈15X2.4	4	GB1235-76
38	Z6004-02202	O-ring 0型密封圈22X2.4	4	GB1235-76
39	JT8022-96021	Elbow 直角接头	1	
40	H14S7-10001	Gear pump 泵	1	2L,2.5t
-	H2F97-10001	Gear pump 泵	1	3t
41	23657-12001	Packing 垫	2	