

序号 Item No	图号 Part No	零件名称 Description	件数 Q'ty	备注 Remark
01	H24C2-40213	Cabinet harness 仪表架线束	1	机械或液力变速箱
02	H25S2-40412	Cabinet harness 仪表架线束	1	电液控制变速箱
03	H24C2-40223	Engine harness 发动机线束	1	机械或液力变速箱
04	H24C2-40422	Engine harness 发动机线束	1	电液控制变速箱
05	H24C2-40231	Rear head guard harness 后护顶架线束	2	
06	Z8498-ZB103S	Combination M/T H2000型组合仪表	1	See Fig.50
07	H24C2-40521	Combination M/T H2001型组合仪表	1	See Fig.51
08	A22A2-40800	Shuck 上壳	1	
09	A22A2-40810	Shuck 下壳	1	
10	A22A2-40820	Cover 后盖	1	
11	H24C2-40601	Control box 控制盒	1	电液控制变速箱
12	A73J2-41302	Switch,direction 方向开关	1	电液控制变速箱
13	JQ1030/04	Relay 启动继电器	1	
14	D06BX2081	Fuse box 保险丝盒	1	
15	Z9260-30100	Belt clip 捆扎带3X100	12	
16	Z9260-40200	Belt clip 捆扎带4X200	8	
17	Z9260-48350	Belt clip 捆扎带4.8X350	2	
18	H24C2-42131	Belt clip 固定可开式锁式扎带	14	
19	HRH24C2404	Rubber ring 出线胶圈	6	
20	H24C2-40701	Rubber ring 防尘胶圈	2	
21	H24C2-40431	Cable,caution light 警示灯线束	1	选用
22	H24C2-40491	Caution light 警示灯	1	选用
23	D0444001	Water temp sending unit 水温传感器	1	发动机附
24	Z8510-120DZ	Back buzzer 倒车蜂鸣器	1	DJB-12B
25	B1010-06016	Bolt 螺钉M6X16	1	GB65-85
26	B5050-00006	Washer,lock 垫圈6	1	GB93-87
27	A22A2-40400	Cable 电瓶引线(-)	1	
28	D016-QW-60	Battery 蓄电池	1	6-QW-60
29	A22A2-40410	Cable 电瓶引线(+)	1	
30	Z2492-42091G	Cable clip 电瓶引线卡	2	

CPQ,CPQD20,25,30-R6
 CPQ,CPQD20H,25H-R11
 CPQ,CPQD30-R12
 CPQ,CPQD35-R3,R4

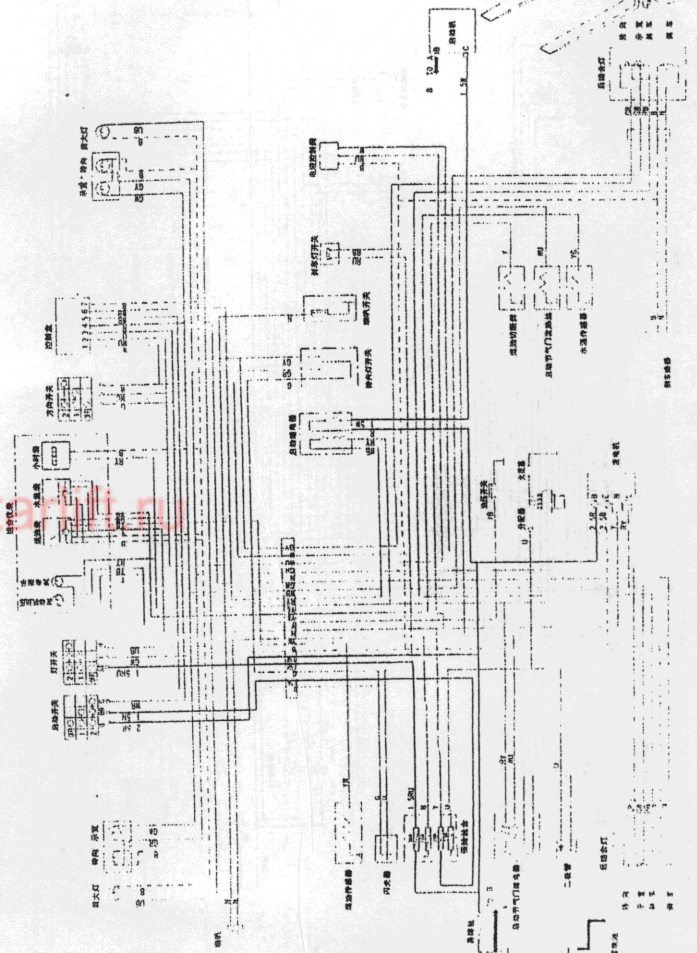
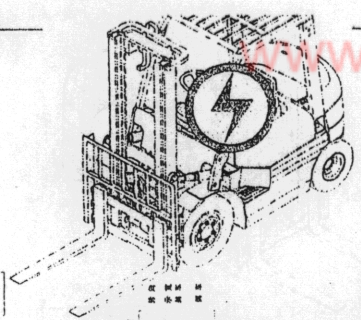

H2000

B

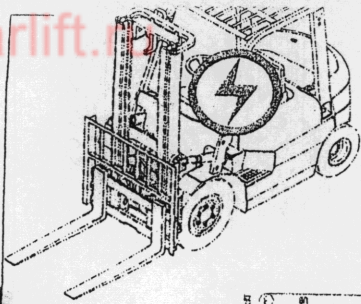

CPQ, CPQD20, 25, 30-R6
CPQ, CPQD20H, 25H-R11
CPQ, CPQD30-R12
CPQ, CPQD35-R3, R4

B

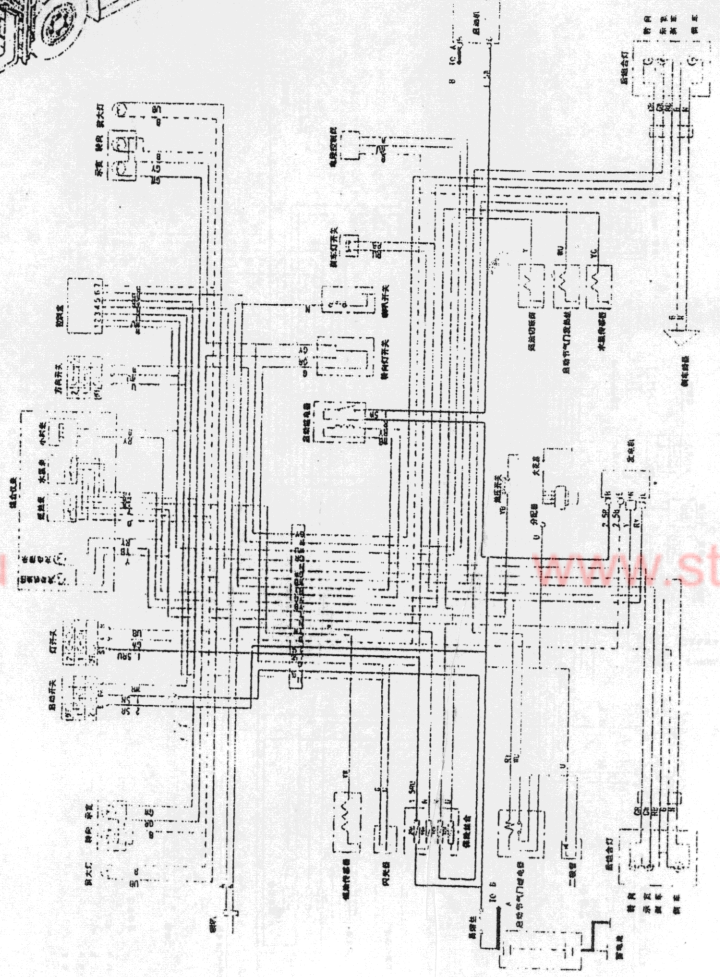

序号 Item No	图号 Part No	零部件名称 Description	件数 Q'ty	备注 Remark
31	A22A2-40900	Fusible link wire	1	易熔线
32	Z8421-18214	Fule level sending unit	1	油量传感器
33	23652-42071G	Cable, head lamp	2	前大灯线束
34	Z8340-1H202	Relay	1	继电器
35	Z8500-1D124	Horn	1	喇叭DL124ED 进口件, H20-11专用
36	B0110-08016	Bolt	1	螺栓M8X16 GB5781-86
37	B5050-00008	Washer, lock	1	垫圈8 GB93-87
38	Z8730-0802A	Switch, turn signal	1	转向灯开关 JK802A
39	Z8600-120WD	Head lamp ass'y	2	前大灯 WD115X80-FC-1L
40	Z8610-12000	Front combination lamp ass'y	2	前组合灯 XH7-1L
41	Z8620-12000	Rear combination lamp ass'y	2	后组合灯 XH8-1L
42	A22A2-42000a	Mat	2	后组合灯垫
43	Z8740-0231D	Brake switch	1	脚制动开关 JK205
44	D07SG152	Flasher unit	1	闪光器
45	B1010-06010	Bolt	1	螺钉M6X10 GB65-85
46	Z8700-JK411	Switch	1	启动开关 JK411
47	D09JK107	Switch	1	灯开关 JK107
48	H24C2-40901	Rearview mirror	1	后视镜 选用
49	H24C2-40291	Control cable	1	喇叭连接线

图42/FIG42

序号 Item No	图号 Part No	零部件名称 Description	件数 Q'ty	备注 Remark
01	H94N2-43001	Cabinet harness	仪表架线束	1
02	H94N2-42001	Engine harness	发动机线束	1
03	D04ZB908JH	Combination M/T	组合仪表	1 See Fig.52
04	JQ1030/04	Relay	启动继电器	1
05	D06BX2081	Fuse box	保险丝盒	1
06	A22A2-40260	Rubber ring	出线胶圈	4
07	Z8510-120DZ	Back buzzer	倒车蜂鸣器	1 DJB-12B
08	B1010-06016	Bolt	螺钉M6X16	1 GB65-85
09	B5050-00006	Washer,lock	垫圈6	1 GB93-87
10	A22A2-40400	Cable	电瓶引线(-)	1
11	Z8100-12060	Battery	蓄电池	1 6-QA-60S
12	A91A2-40410	Cable	电瓶引线(+)	1
13	22492-42091G	Cable clip	电瓶引线卡	2
14	A22A2-40900	Fusible link wire	易熔线	1
15	Z8421-18214	Fule level sending unit	油量传感器	1
16	23652-42071G	Cable,head lamp	前大灯线束	2
17	Z8500-1D124	Horn	喇叭DL124ED	1
18	B0110-08016	Bolt	螺栓M8X16	1 GB5780-86
19	B5050-00008	Washer,lock	垫圈8	1 GB93-87
20	Z8730-0802A	Switch,turn signal	转向灯开关	1 JK802A
21	Z8600-120WD	Head lamp ass'y	前大灯	2 WD115X80-FC-1L
22	Z8610-12000	Front combination lamp ass'y	前组合灯	2 XH7-1L
23	Z8620-12000	Rear combination lamp ass'y	后组合灯	2 XH8-1L
24	A22A2-42000a	Mat	后组合灯垫	2
25	Z8740-0231D	Brake switch	脚制动开关	1 JK205
26	D07SG152	Flasher unit	闪光器	1
27	B1010-06010	Bolt	螺钉M6X10	2 GB65-85
28	Z8411-12703	Water temp sending unit	水温传感器	1
29	H24C2-40701	Rubber ring	防尘胶圈	2
30	Z8340-1H202	Relay	继电器	1

CPQ,CPQD20,25,30,35-ZJ2

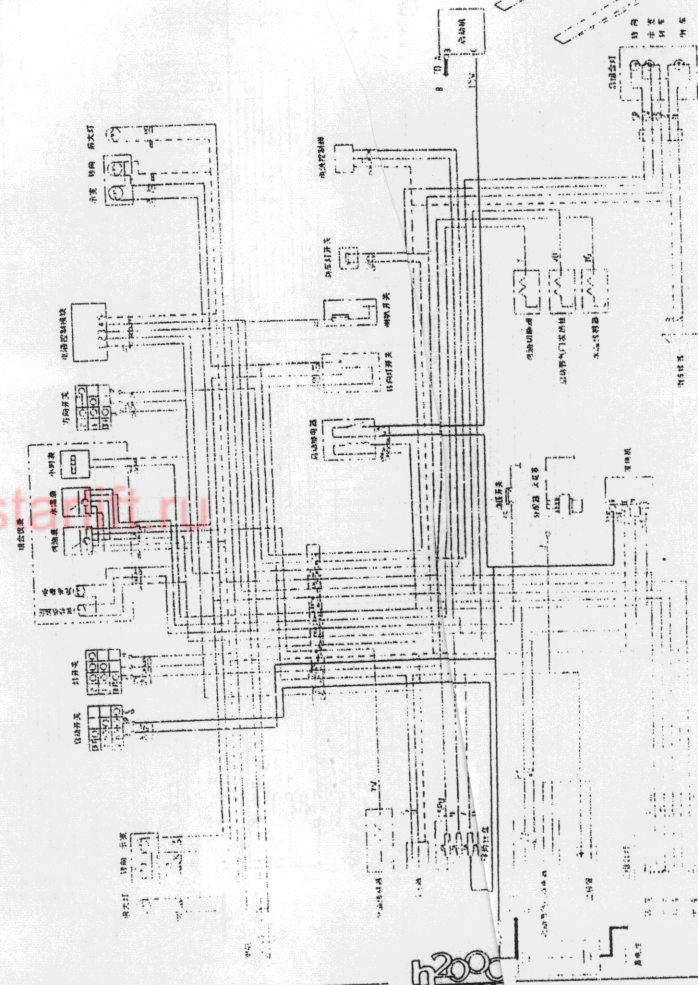
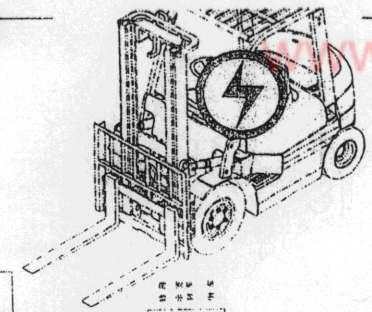

B

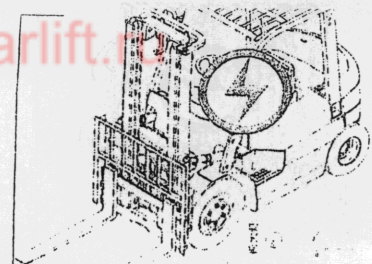

B

CPQ,CPQD20,25,30,35-ZJ3

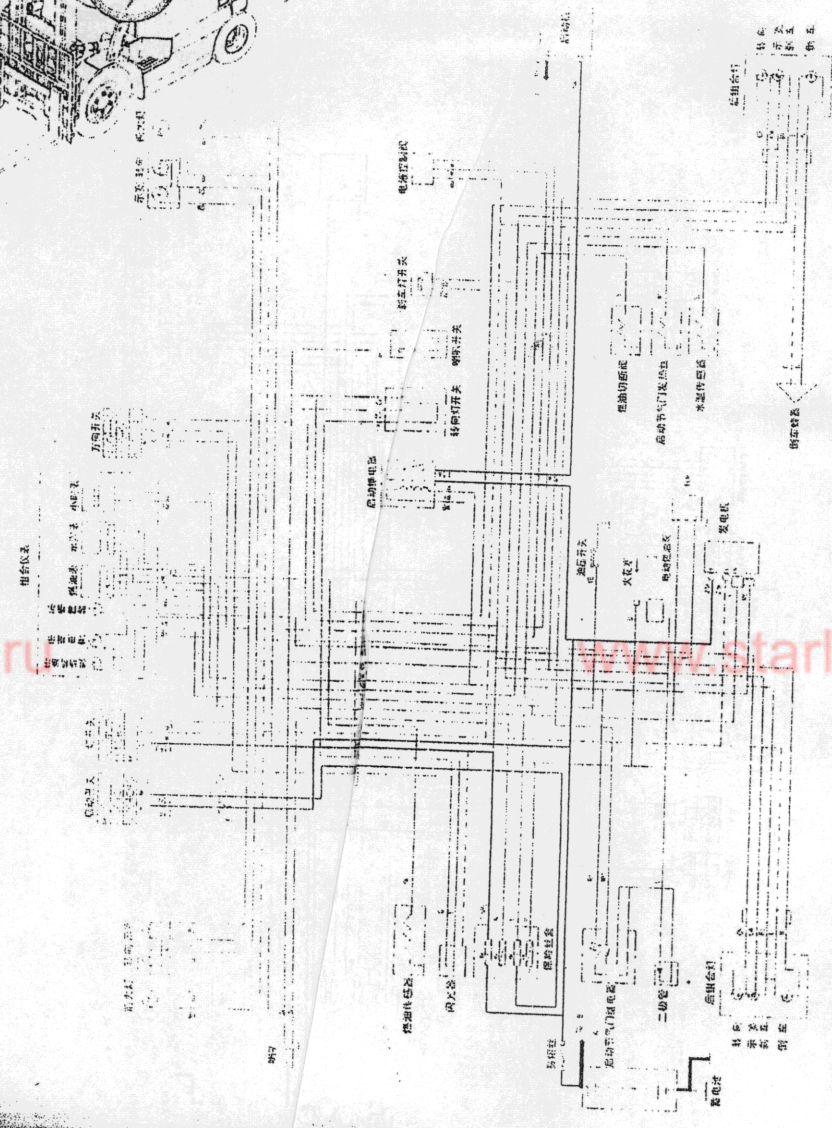

44

HELI

序号 Item No	图号 Part No	零部件名称 Description	件数 Q'ty	备注 Remark
A	H96N2-40001	Electric system	1	电气系统
01	H96N2-42001	Cabinet harness	1	仪表架线束
02	H96N2-41001	Engine harness	1	发动机线束
03	D04ZB908GZ	Combination M/T	1	组合仪表 See Fig.52
04	JQ1030/04	Relay	1	启动继电器
05	D06BX2081	Fuse box	1	保险丝盒 BX2081
06	A22A2-40260	Rubber ring	4	出线胶圈
07	Z8510-120DZ	Back buzzer	1	倒车蜂鸣器 DJB-12B
08	B1010-06016	Bolt	1	螺钉M6X16 GB65-85
09	B5050-00006	Washer,lock	1	垫圈6 GB93-87
10	A22A2-40400	Cable	1	电瓶引线(-)
11	Z8100-12060	Battery	1	蓄电池 6-QA-60S
12	A91A2-40500	Cable	1	电瓶引线(+)
13	Z2492-42091G	Cable clip	2	电瓶引线卡
14	A22A2-40900	Fusible link wire	1	易熔线
15	Z8421-18214	Fule level sending unit	1	油量传感器
16	Z3652-42071G	Cable,head lamp	2	前大灯线束
17	Z8500-1D124	Horn	1	喇叭DL124ED
18	B0110-08016	Bolt	1	螺栓M8X16 GB5780-86
19	B5050-00008	Washer,lock	1	垫圈8 GB93-87
20	Z8730-0802A	Switch,turn signal	1	转向灯开关 JK802A
21	Z8600-120WD	Head lamp ass'y	2	前大灯 WD115X80-FC-1L
22	Z8610-12000	Front combination lamp ass'y	2	前组合灯 XH7-1L
23	Z8620-12000	Rear combination lamp ass'y	2	后组合灯 XH8-1L
24	A22A2-42000a	Mat	2	后组合灯垫
25	Z8740-0231D	Brake switch	1	脚制动开关 JK205
26	D07SG152	Flasher unit	1	闪光器
27	B1010-06010	Bolt	2	螺钉M6X10 GB65-85
28	Z8411-12703	Water temp sending unit	1	水温传感器
29	H24C2-40701	Rubber ring	2	防尘胶圈
30	Z8340-1H202	Relay	1	继电器

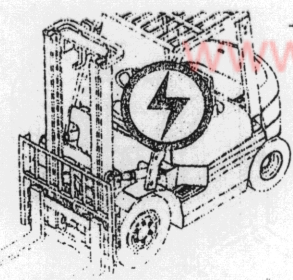

B

序号 Item No.	图号 Part No	零部件名称 Description	件数 Q'ty	备注 Remark
01	H25S2-40213	Cabinet harness	1	机械或液力变速箱
02	H25S2-40412	Cabinet harness	1	液力控制变速箱
03	H25S2-40223	Engine harness	1	CPC(D)20-30-W7,W9 CPC(D)35-W5,W6 机械或液力变速箱
-	H25N2-40223	Engine harness	1	CPC(D)20-30-W8 CPC(D)35-W4 机械或液力变速箱
04	H25S2-40422	Engine harness	1	CPC(D)20-30-W7,W9 CPC(D)35-W5,W6 液力控制变速箱
-	H25N2-40422	Engine harness	1	CPC(D)20-30-W8 CPC(D)35-W4 液力控制变速箱
05	H24C2-40231	Rear head guard harness	2	后护顶架线束
06	Z8498-ZB103	Combination M/T	1	H2000型组合仪表 See Fig.50
07	H24C2-40511	Combination M/T	1	H2001型组合仪表 See Fig.51
08	A22A2-40800	Shuck	1	上壳
09	A22A2-40810	Shuck	1	下壳
10	A22A2-40820	Cover	1	后盖
11	H24C2-40601	Control box	1	控制盒 液力控制变速箱
12	A73J2-41302	Switch,direction	1	方向开关 液力控制变速箱
13	JQ1030/04	Relay	1	启动继电器
14	D06BX2081	Fuse box	1	保险丝盒
15	Z9260-30100	Belt clip	12	捆扎带3X100
16	Z9260-40200	Belt clip	8	捆扎带4X200
17	Z9260-48350	Belt clip	2	捆扎带4.8X350
18	H24C2-42131	Belt clip	14	固定可开式锁式扎带
19	HRH24C2404	Rubber ring	5	出线胶圈
20	H24C2-40701	Rubber ring	2	防尘胶圈
21	H24C2-40431	Cable,caution light	1	警示灯线束 选用
22	H24C2-40491	Caution light	1	警示灯 选用
23	Z8411-12703	Water temp sending unit.	1	水温传感器
24	Z8510-120DZ	Back buzzer	1	倒车蜂鸣器 DJB-12B
25	B1110-06016	Bolt	1	螺钉M6X16 GB65-85
26	B5050-00006	Washer,lock	1	垫圈 GB93-87
27	A22A2-40400	Cable	1	电瓶引线(-)
28	D016-QW-80	Battery	1	蓄电池 6-QW-80

CPC,CPCD20,25,30-W7,W8,W9
CPC,CPCD35-W4,W5,W6

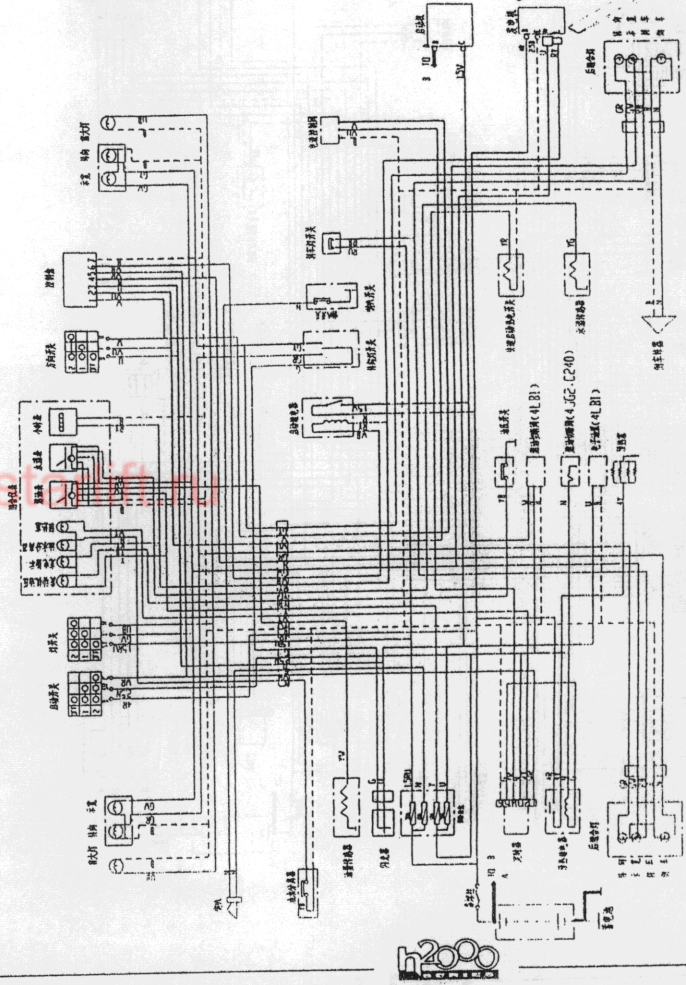

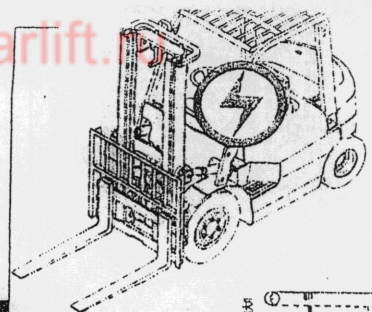

CPC, CPCD20, 25, 30-W7, W8, W9
CPC, CPCD35-W4, W5, W6

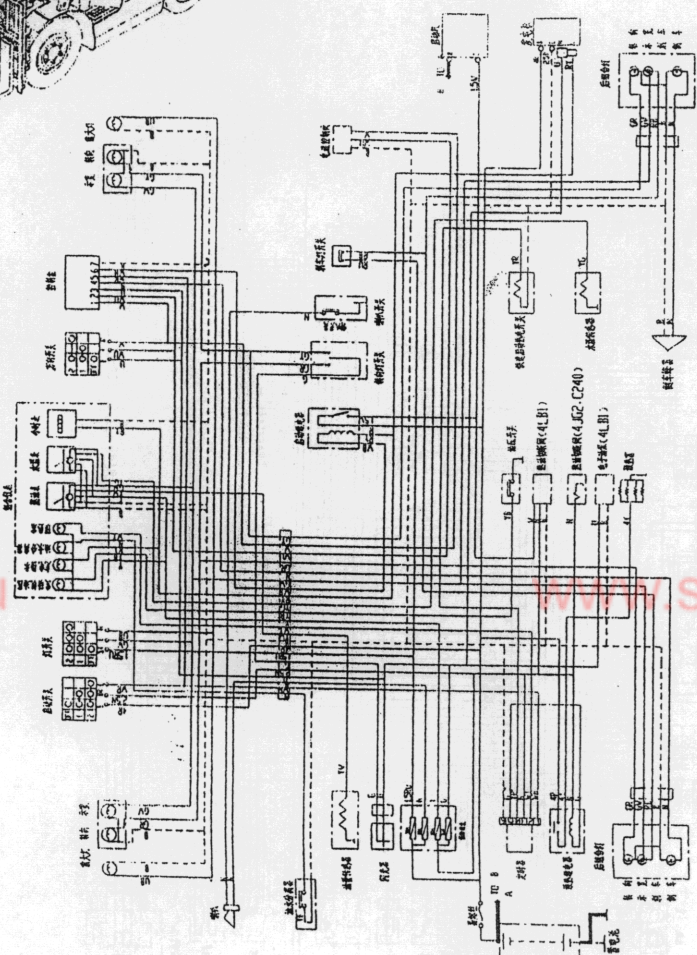

序号 Item No	图号 Part No	零部件名称 Description	件数 Q'ty	备注 Remark
29	A22A2-40420	Cable	1	电瓶引线(+)
30	22492-42091G	Cable clip	2	电瓶引线卡
31	A22A2-40900	Fusible link wire	1	易熔线
32	Z8421-18214	Fule level sending unit	1	油量传感器
33	23652-42071G	Cable, head lamp	2	前大灯线束
34	Z8900-12Q0S	Timer	1	进口件 21152-42012 定时器
35	Z8930-10000	Relay	1	进口件 21152-42021 继电器
36	Z8500-1D124	Horn	1	喇叭DL124ED
37	B0110-08016	Bolt	1	螺栓M8X16 GB5781-86
38	B5050-00008	Washer, lock	1	垫圈8 GB93-87
39	Z8730-0802A	Switch, turn signal	1	转向灯开关 JK802A
40	Z8600-120WD	Head lamp ass'y	2	前大灯 WD115X80-FC-1L
41	Z8610-12000	Front combination lamp ass'y	2	前组合灯 XH7-1L
42	Z8620-12000	Rear combination lamp ass'y	2	后组合灯 XH8-1L
43	A22A2-42000a	Mat	2	后组合灯垫
44	Z8740-0231D	Brake switch	1	脚制动开关 JK205
45	D07SG152	Flasher unit	1	闪光器
46	B1110-06010	Bolt	1	螺钉M6X10
47	Z8700-JK411	Switch	1	启动开关 JK411
48	D09JK211	Switch	1	灯开关 JK 211
49	H24C2-40901	Rearview mirror	1	后视镜 选用

B

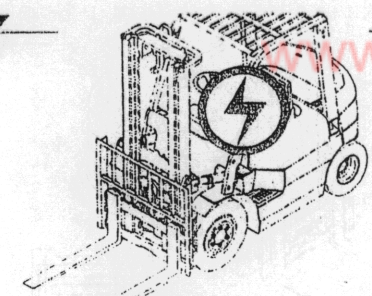

B

序号 Item No.	图号 Part No	零部件名称 Description	件数 Q'ty	备注 Remark
1	H25S2-40213	Cabinet harness 仪表架线束	1	机液控制
2	H25S2-40412	Cabinet harness 仪表架线束	1	电液控制
3	H21U2-40221	Engine harness 发动机线束	1	机液控制
4	H21U2-40421	Engine harness 发动机线束	1	电液控制
5	H24C2-40231	Rear head guard harness 后护顶架线束	2	
6	Z8498-ZB103	Combination M/T H2000型组合仪表	1	标准型 See Fig.50
7	H24C2-40511	Combination M/T H2001型组合仪表	1	选用 See Fig.51
8	A22A2-40800	Shuck 上壳	1	
9	A22A2-40810	Shuck 下壳	1	
10	A22A2-40820	Cover 后盖	1	
11	H24C2-40601	Control box 控制盒	1	电液控制
12	A73J2-41302	Switch,direction 方向开关	1	电液控制
13	JQ1030/04	Relay 启动继电器	1	
14	Z9260-40100	Belt clip 捆扎带4X100	12	
15	Z9260-40200	Belt clip 捆扎带4X200	8	
16	Z9260-48350	Belt clip 捆扎带4.8X350	2	
17	H24C2-42131	Belt clip 固定可开式锁式扎带	14	
18	D06BX2083	Fuse box 保险丝盒	1	
19	HRH24C2404	Rubber ring 出线胶圈	5	
20	H24C2-40701	Rubber ring 防尘胶圈	1	
21	H24C2-40431	Wiring harness, Caution light 警示灯线束	1	
22	H24C2-40491	Caution light 警示灯	1	
23	Z8411-12703	Water temp sending unit 水温传感器	1	
24	Z8510-120DZ	Back buzzer 倒车蜂鸣器	1	DJB-128
25	B1110-06016	Bolt 螺钉M6X16	1	GB65-85
26	B5050-00006	Washer, lock 垫圈6	1	GB93-87
27	A22A2-40400	Cable 电瓶引线(-)	1	
28	Z8110-12105	Battery 蓄电池	1	6-QA-105S
29	A22A2-40420	Cable 电瓶引线(+)	1	
30	22492-42091G	Cable clip 电瓶引线卡	2	

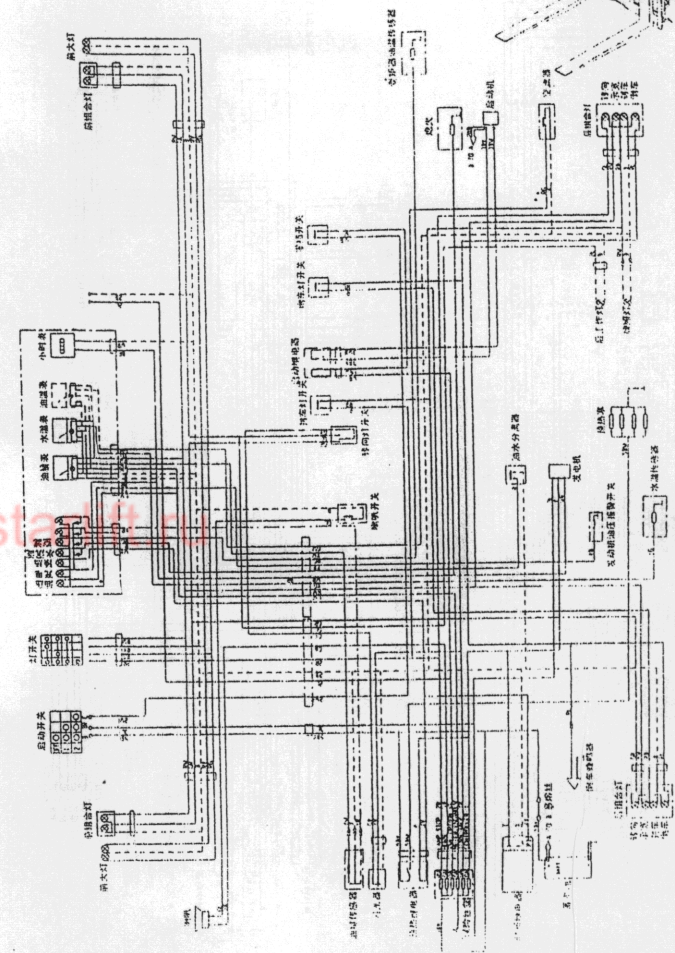

CPC,CPCD20,25,30,35-Xs1

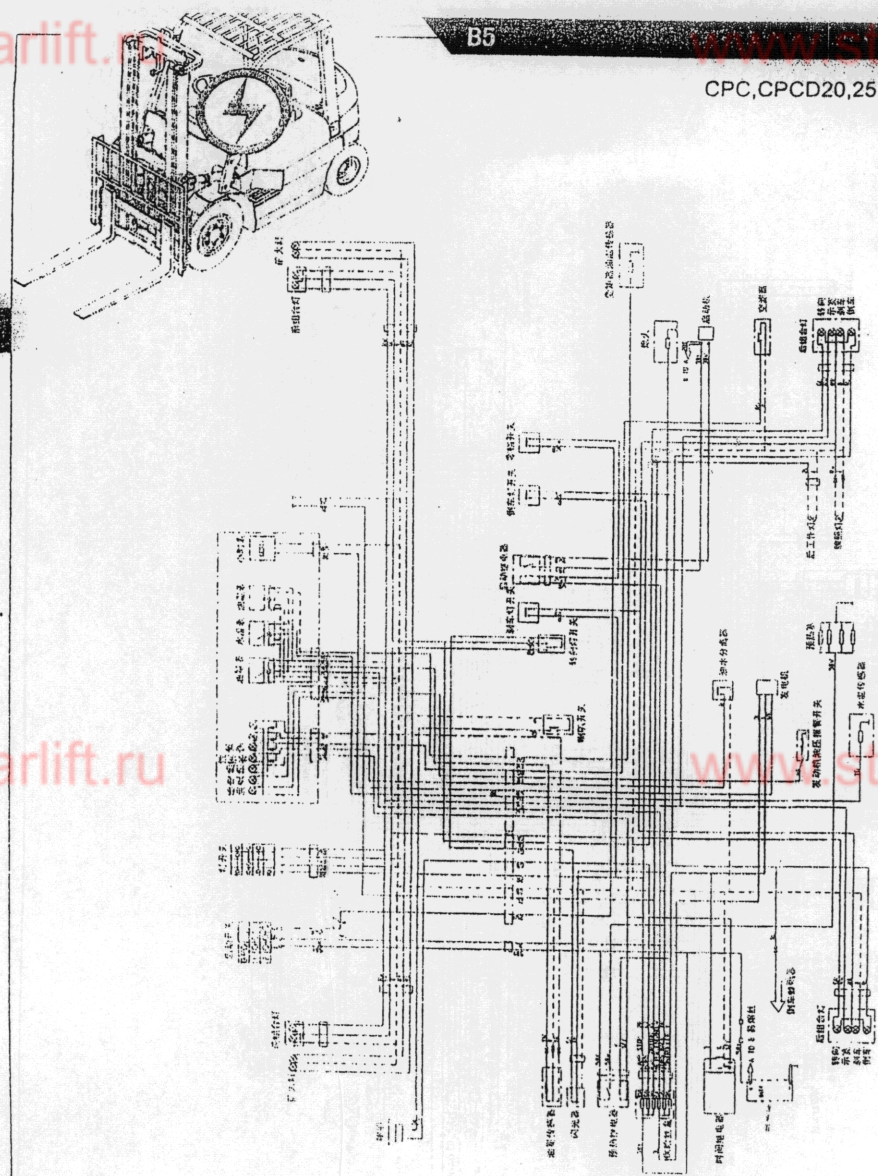

序号 Item No	图号 Part No	零部件名称 Description	件数 Q'ty	备注 Remark
31	A22A2-40900	Fusible link wire	易熔线 2	
32	Z8421-18214	Fule level sending unit	油量传感器 1	
33	23652-42071G	Cable,head lamp	前大灯线束 2	
34	JQK1	Relay	时间继电器 1	
35	JQ1030/04	Relay	预热继电器 1	
36	Z8500-1D124	Horn	喇叭DL124ED 1	
37	B0110-08016	Bolt	螺栓M8X16 1	GB5781-86
38	B5050-00008	Washer,lock	垫圈8 1	GB93-87
39	Z8730-0802A	Switch,turn signal	转向灯开关 1	JK802A
40	Z8600-120WD	Head lamp ass'y	前大灯 2	WD115x80-FC-1L
41	Z8610-12000	Front combination lamp ass'y	前组合灯 2	XH7-1L
42	Z8620-12000	Rear combination lamp ass'y	后组合灯 2	XH8-1L
43	A22A2-42000a	Mat	后组合灯垫 2	
44	Z8740-0231D	Brake switch	脚制动开关 1	JK205
45	D07SG152	Flasher unit	闪光器 1	
46	B1110-06010	Bolt	螺钉M6X10 1	
47	Z8700-JK411	Key switch	启动开关 1	JK411
48	D09JK211	light switch	灯开关 1	JK211
49	H24C2-40901	Rearview mirror	后视镜 1	选用

B

图46/FIG46

序号 Item No	图号 Part No	零件名称 Description	件数 Q'ty	备注 Remark
1	A23F2-40214	Cabinet harness 仪表架线束	1	机液控制
2	H25S2-40412	Cabinet harness 仪表架线束	1	电液控制
3	A91A2-40224	Engine harness 发动机线束	1	机液控制
4	H93C2-40421	Engine harness 发动机线束	1	电液控制
5	H24C2-40231	Rear head guard harness 后护顶架线束	2	
6	Z8498-ZB103	Combination M/T H2000型组合仪表	1	标准型 See Fig.50
7	H24C2-40511	Combination M/T H2001型组合仪表	1	选用 See Fig.51
8	A22A2-40800	Shuck 上壳	1	
9	A22A2-40810	Shuck 下壳	1	
10	A22A2-40820	Cover 后盖	1	
11	H24C2-40601	Control box 控制盒	1	电液控制
12	A73J2-41302	Switch,direction 方向开关	1	电液控制
13	Z9260-40100	Belt clip 捆扎带4X100	12	
14	Z9260-40200	Belt clip 捆扎带4X200	8	
15	Z9260-48350	Belt clip 捆扎带4.8X350	2	
16	Z9260-800350	Belt clip 捆扎带8X350	4	
17	D06BX2081	Fuse box 保险丝盒	1	
18	HRH24C2404	Rubber ring 出线胶圈	7	
19	Z8411-12703	Water temp sending unit 水温传感器	1	
20	Z8510-120DZ	Back buzzer 倒车蜂鸣器	1	DJB-128
21	B1110-06016	Bolt 螺钉M6X16	3	GB65-85
22	B5050-00006	Washer,lock 垫圈6	3	GB93-87
23	HRA91A2402	Cable 电瓶引线	1	
24	D016-QW-120	Battery 蓄电池	1	6-QW-120
25	22492-42091G	Cable clip 电瓶引线卡	1	
26	A22A2-40900	Fusible link wire 易熔线	2	
27	Z8421-18214	Fule level sending unit 油量传感器	1	
28	Z3652-42071G	Cable,head lamp 前大灯线束	1	
29	JQK1	Relay 时间继电器	1	
30	JQ1030/04	Relay 预热继电器	2	1件用于启动继电器

CPC, CPCD20, 25, 30-X6
CPC, CPCD35-X2

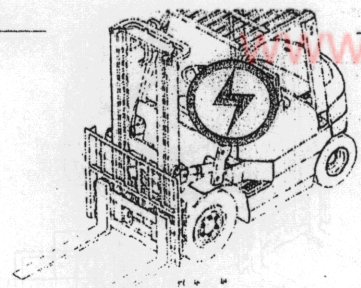
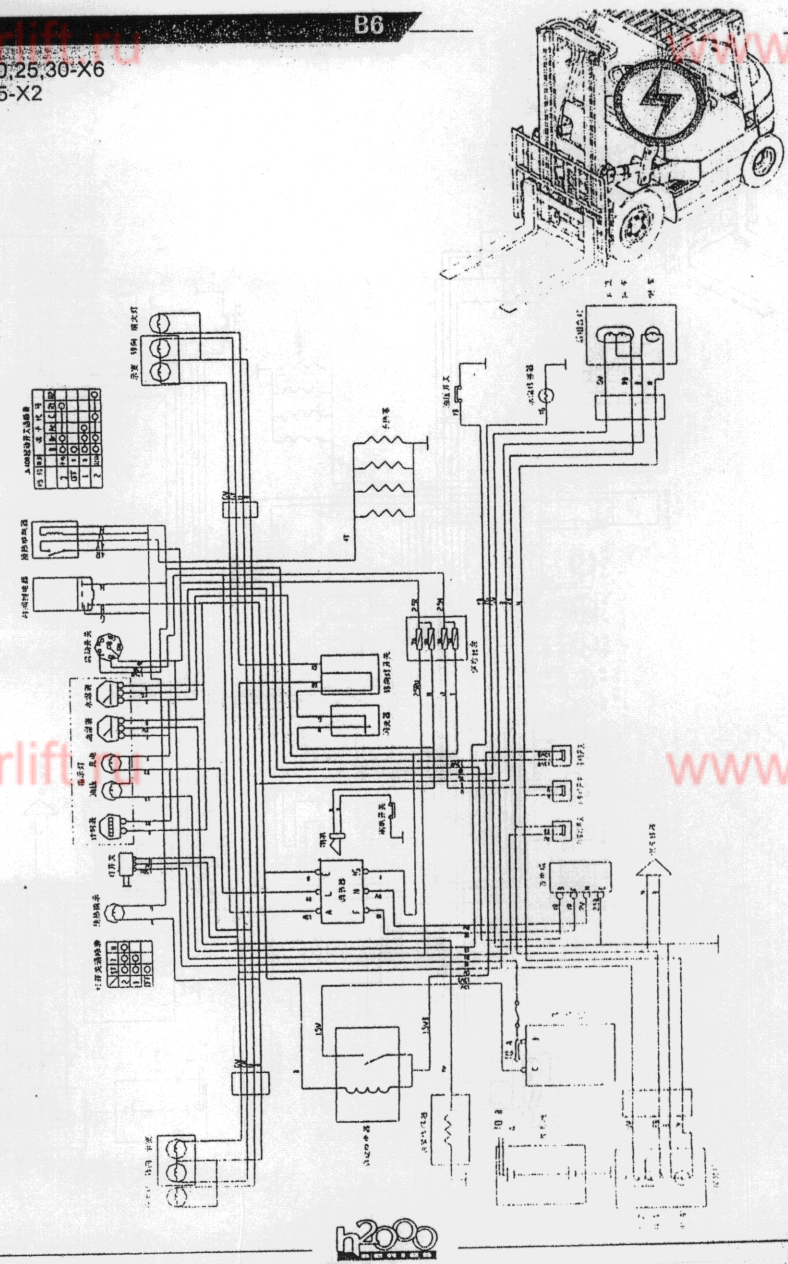

CPC, CPCD20, 25, 30-X6
CPC, CPCD35-X2

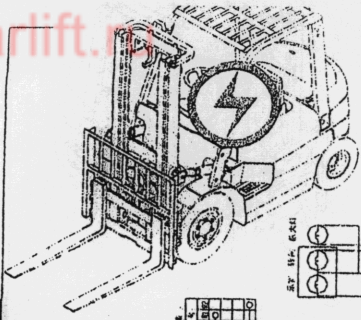

B

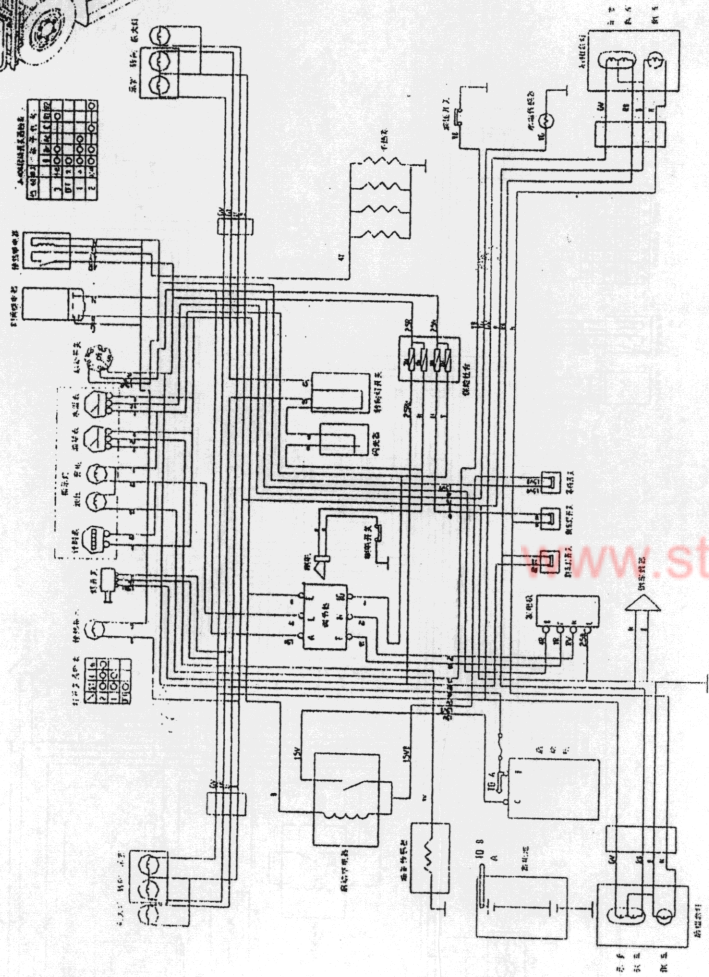

序号 Item No	图号 Part No	零部件名称 Description	件数 Q'ty	备注 Remark
31	Z8500-1D124	Horn	喇叭DL124ED 1	
32	B0110-08016	Bolt	螺栓M8X16 1	GB5781-86
33	B5050-00008	Washer, lock	垫圈8 1	GB93-87
34	Z8730-0802A	Switch, turn signal	转向灯开关 1	JK802A
35	Z8600-120WD	Head lamp ass'y	前大灯 2	WD115x80-FC-1L
36	Z8610-12000	Front combination lamp ass'y	前组合灯 2	XH7-1L
37	Z8620-12000	Rear combination lamp ass'y	后组合灯 2	XH8-1L
38	A22A2-42000a	Mat	后组合灯垫 2	
39	Z8740-0231D	Brake switch	脚制动开关 1	JK205
40	D07SG152	Flasher unit	闪光器 1	
41	B1110-06010	Bolt	螺钉M6X10 1	
42	Z8300-10147	Adjustment	调节器 1	JFT147
43	D09JK211	Light switch	灯开关 1	JK211
44	H24C2-40701	Rubber ring	防尘胶圈 1	
45	B5210-00006	Washer	平垫圈6 2	GB97.1-85
46	H24C2-40491	Caution light	警示灯 1	选用件
47	H24C2-40431	Cable, caution light	警示灯线束 2	选用件
48	H24C2-40901	Rearview mirror	后视镜 1	选用件

序号 Item No	图号 Part No	零部件名称 Description	件数 Q'ty	备注 Remark
1	H25S2-40213	Cabinet harness 仪表架线束	1	机液控制
2	H25S2-40412	Cabinet harness 仪表架线束	1	电液控制
3	H97Y2-40221	Engine harness 发动机线束	1	机液控制
4	H97Y2-40421	Engine harness 发动机线束	1	电液控制
5	H24C2-40231	Rear head guard harness 后护顶架线束	2	
6	P62B2-40201	Combination M/T H2000型组合仪表	1	标准 See Fig.50
-	D04ZB908JH	Combination M/T 组合仪表	1	选用 See Fig.52
7	D09JK211	Light switch 灯开关	1	JK211
8	A22A2-40800	Shuck 上壳	1	
9	A22A2-40810	Shuck 下壳	1	
10	A22A2-40820	Cover 后盖	1	
11	H24C2-40601	Control box 控制盒	1	电液控制
12	A73J2-41302	Switch,direction 方向开关	1	电液控制
13	5-82550-029-0	Relay 继电器	1	
14	Z9260-40100	Belt clip 捆扎带4X100	12	
15	Z9260-40200	Belt clip 捆扎带4X200	8	
16	Z9260-48350	Belt clip 捆扎带4.8X350	2	
17	H24C2-42131	Belt clip 固定可开式锁式扎带	14	
18	D06BX2083	Fuse box 保险丝盒	1	
19	HRH24C2404	Rubber ring 出线胶圈	5	
20	H24C2-40701	Rubber ring 防尘胶圈	1	
21	H24C2-40431	Wiring harness,Caution light 警示灯线束	1	
22	H24C2-40491	Caution light 警示灯	1	
23	Z8411-12703	Water temp sending unit 水温传感器	1	
24	Z8510-120DZ	Back buzzer 倒车蜂鸣器	1	DJB-128
25	B1110-06016	Bolt 螺钉M6X16	1	GB65-85
26	B5050-00006	Washer,lock 垫圈	6	GB93-87
27	24942-42081G	Cable 电瓶引线(-)	1	
28	D016-QW-80	Battery 蓄电池	1	6-QW-80
29	A22A2-40420	Cable 电瓶引线(+)	1	

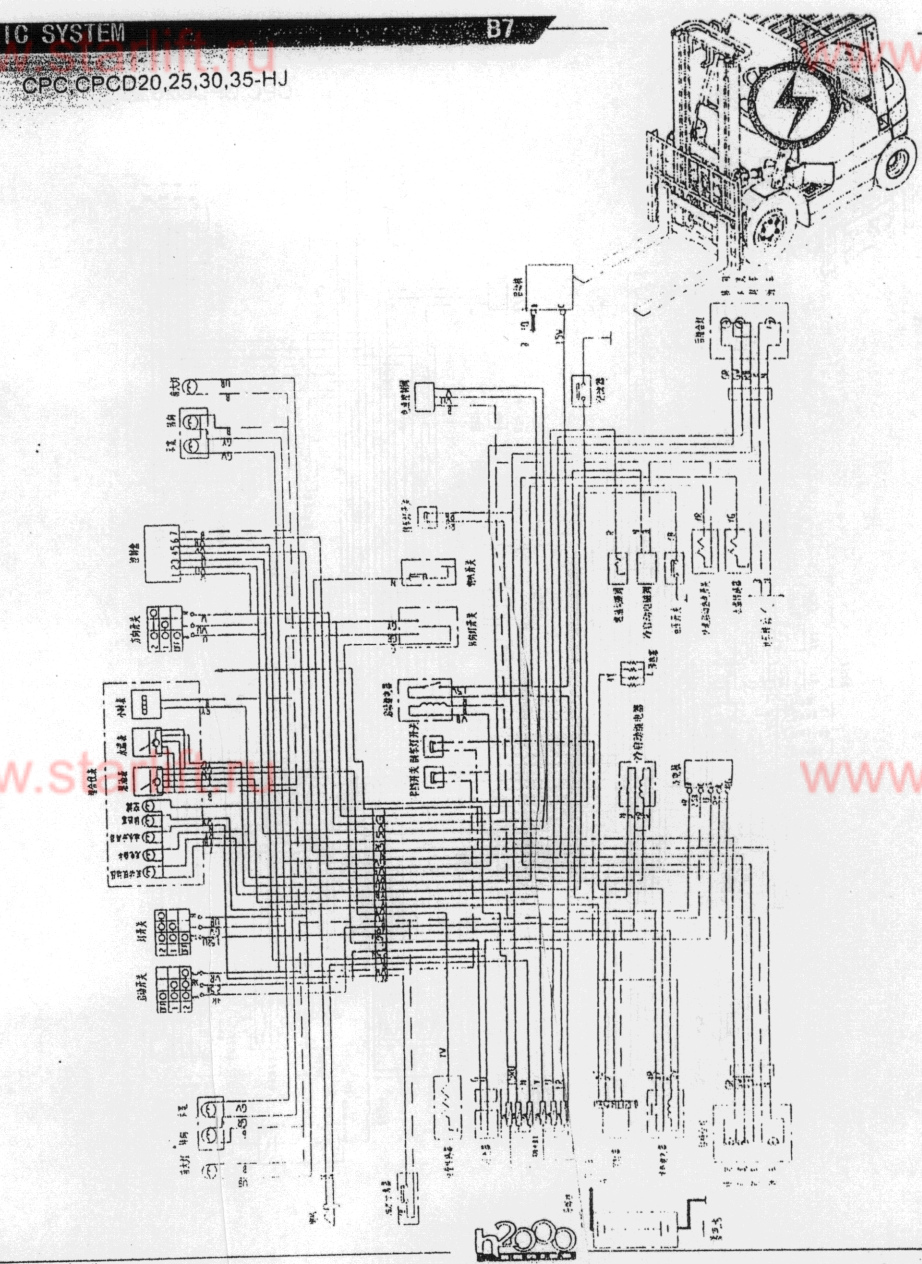

CPC, CPCD20, 25, 30, 35-HJ

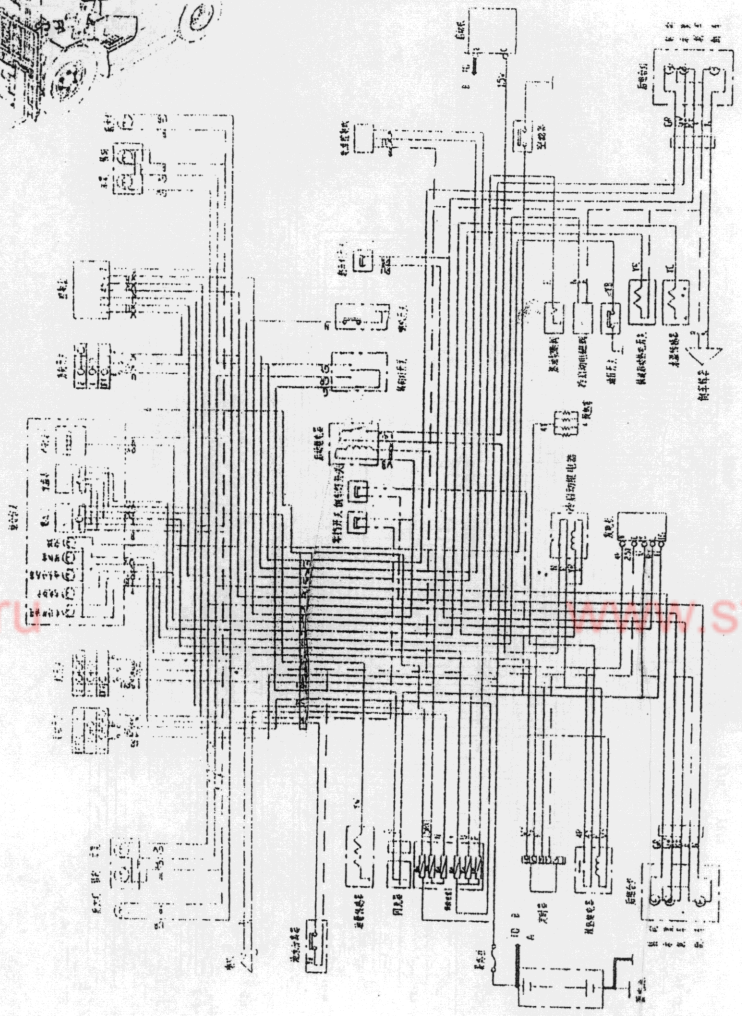
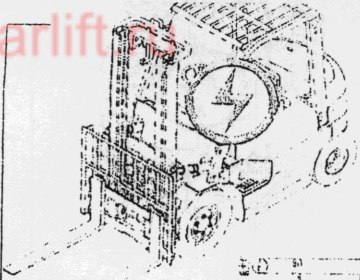

序号 Item No	图号 Part No	零部件名称 Description	件数 Q'ty	备注 Remark
30	Z2492-42091G	Cable clip	2	电瓶引线卡
31	A22A2-40900	Fusible link wire	2	易熔线
32	Z8421-18214	Fule level sending unit	1	油量传感器
33	Z3652-42071G	Cable, head lamp	2	前大灯线束
34	JQK1	Relay	1	时间继电器
35	JQ1030/04	Relay	2	预热继电器
36	Z8500-1D124	Horn	1	喇叭DL124ED
37	B0110-08016	Bolt	1	螺栓M8X16 GB5781-86
38	B5050-00008	Washer, lock	1	垫圈8 GB93-87
39	Z8730-0802A	Switch, turn signal	1	转向灯开关 JK802A
40	Z8600-120WD	Head lamp ass'y	2	前大灯 WD115x80-FC-1L
41	Z8610-12000	Front combination lamp ass'y	2	前组合灯 XH7-1L
42	Z8620-12000	Rear combination lamp ass'y	2	后组合灯 XH8-1L
43	A22A2-42000a	Mat	2	后组合灯垫
44	Z8740-0231D	Brake switch	1	脚制动开关 JK205
45	D07SG152	Flasher unit	1	闪光器
46	B1010-06010	Bolt	1	螺钉M6X10 GB65-85
47	Z8700-JK411	Key switch	1	启动开关 JK411

序号 Item No	图号 Part No	零部件名称 Description	件数 Q'ty	备注 Remark
1	A23F2-40214	Cabinet harness 仪表架线束	1	机械或液力变速箱
2	H25S2-40411	Cabinet harness 仪表架线束	1	电液控制变速箱
3	H99Y2-40221	Engine harness 发动机线束	1	机械或液力变速箱
4	H99Y2-40421	Engine harness 发动机线束	1	电液控制变速箱
5	H24C2-40231	Rear head guard harness 后护顶架线束	2	
6	D04ZB908JH	Combination M/T 组合仪表	1	See Fig.52
7	H24C2-40701	Rubber ring 防尘胶圈	2	
8	A22A2-40800	Shuck 上壳	1	
9	A22A2-40810	Shuck 下壳	1	
10	A22A2-40820	Cover 后盖	1	
11	H24C2-40601	Control box 控制盒	1	电液控制变速箱
12	A73J2-41302	Switch,direction 方向开关	1	电液控制变速箱
13	Z9260-30100	Belt clip 捆扎带3X100	12	
14	Z9260-40200	Belt clip 捆扎带4X200	8	
15	Z9260-48350	Belt clip 捆扎带4.8X350	2	
16	Z9260-80350	Belt clip 捆扎带8X350	4	
17	D06BX2081	Fuse box 保险丝盒	1	BX2081
18	HRH24C2404	Rubber ring 出线胶圈	7	
19	HRH24C2404*2	Rubber ring 出线胶圈	7	
20	Z8510-120DZ	Back buzzer 倒车蜂鸣器	1	DJB-128
21	B1010-06016	Bolt 螺钉M6X16	1	GB65-85
22	B5050-00006	Washer,lock 垫圈6	1	GB93-87
23	A91A2-40600	Cable 电瓶引线(+)	1	
24	24942-42081G	Cable 电瓶引线(-)	1	
25	D016-QW-80	Battery 蓄电池	1	6-QW-80
26	HAH92A2401 22492-42091G	Cable clip 电瓶引线卡	1	
27	HAH92A2401 22492-42092G	Cable clip 电瓶引线卡	1	
28	A22A2-40900	Fusible link wire 易熔线	2	
29	Z8421-18214	Fule level sending unit 油量传感器	1	
30	Z3652-42071G	Cable,head lamp 前大灯线束	1	

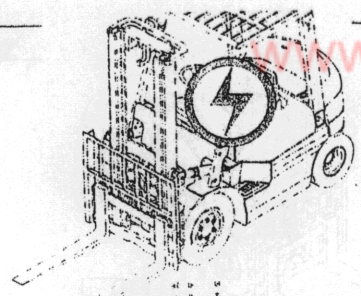
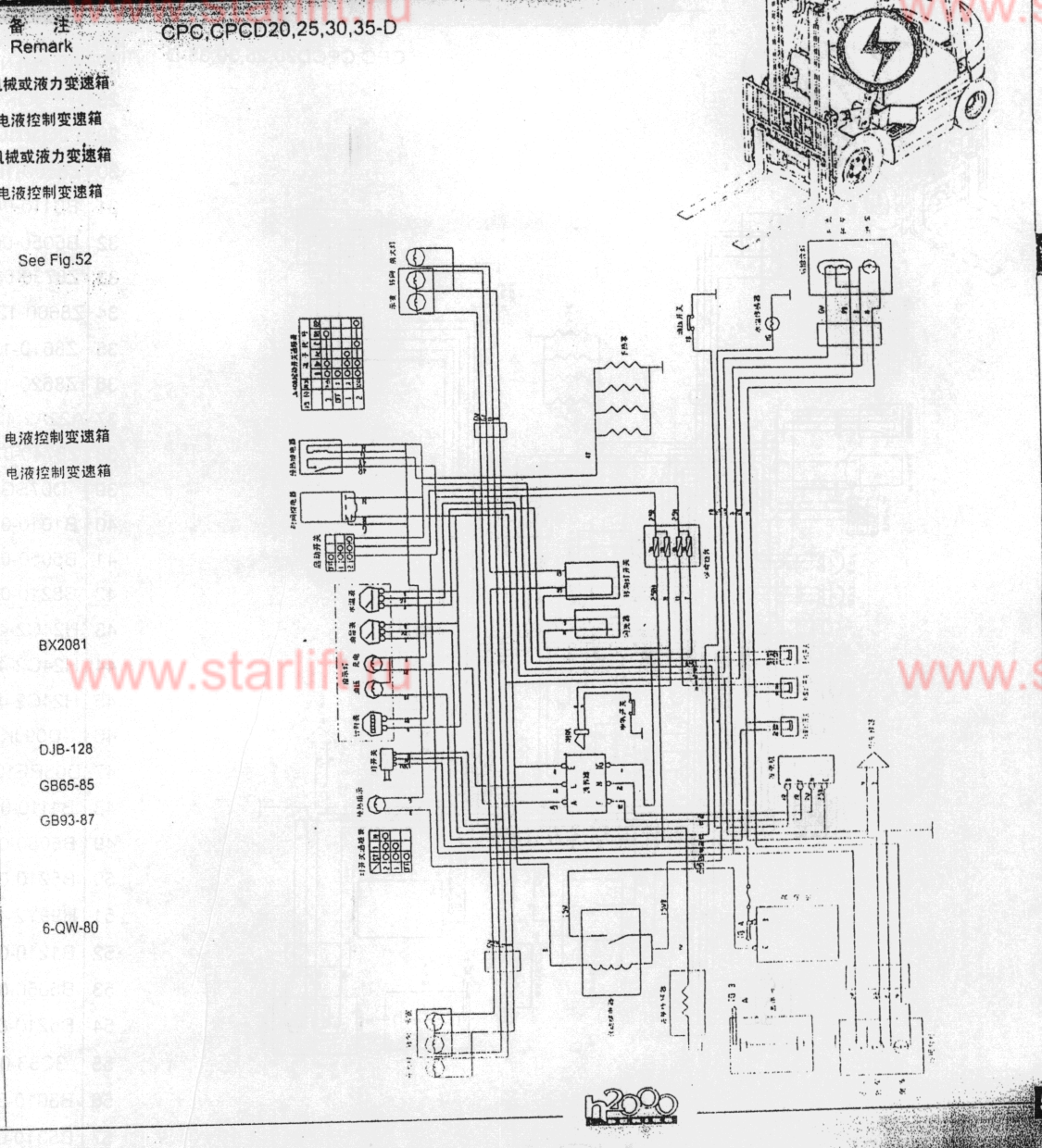

B

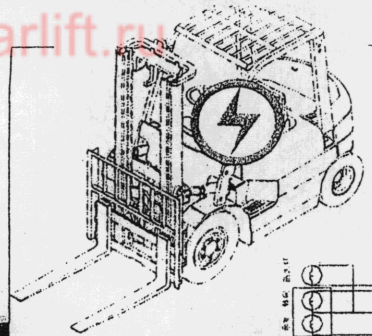

B

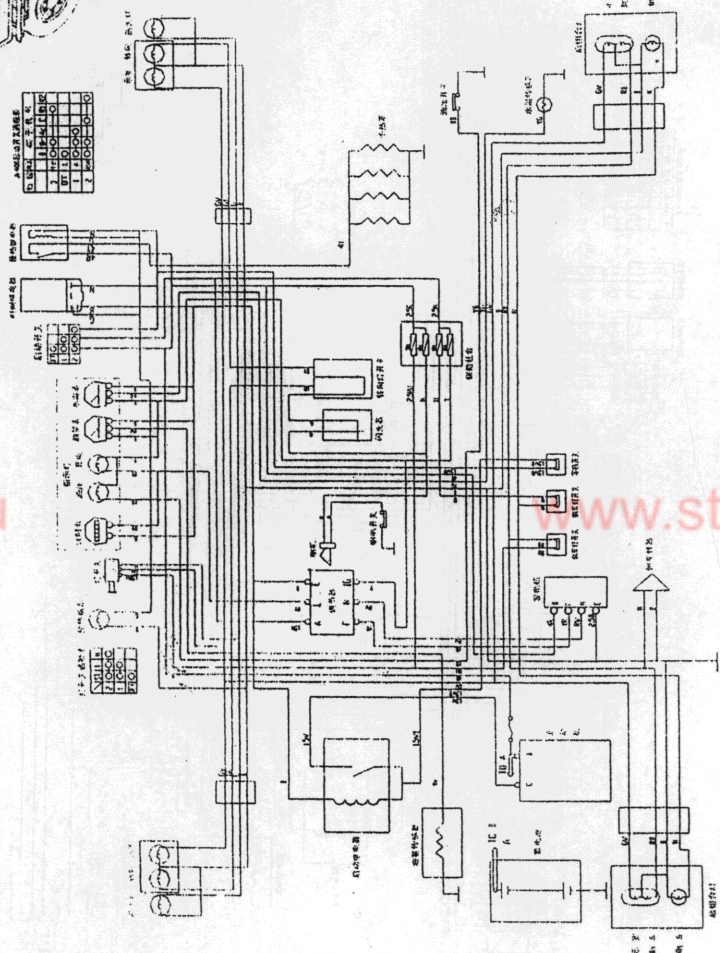

CPC, CPCD20, 25, 30, 35-D

序号 Item No	图号 Part No	零部件名称 Description	件数 Q'ty	备注 Remark
28	JQK1	Relay	1	时间继电器
29	JQ1030/04	Relay	2	1件用于启动继电器 预热继电器
30	Z8500-1D124	Horn	1	喇叭DL124ED
31	B0110-08016	Bolt	1	螺栓M8X16 GB5781-86
32	B5050-00008	Washer, lock	1	垫圈8 GB93-87
33	Z8730-0802A	Switch, turn signal	1	转向灯开关 JK802A
34	Z8600-120WD	Head lamp ass'y	2	前大灯 WD115X80-FC-1L
35	Z8610-12000	Front combination lamp ass'y	2	前组合灯 XH7-1L
36	Z8620-12000	Rear combination lamp ass'y	2	后组合灯 XH8-1L
37	A22A2-42000a	Mat	2	后组合灯垫
38	Z8740-0231D	Brake switch	1	脚制动开关 JK205
39	D07SG152	Flasher unit	1	闪光器 SG152
40	B1010-06010	Bolt	1	螺钉M6X10 GB65-85
41	B5050-00006	Washer, lock	2	垫圈6 GB93-87
42	B5210-00006	Washer	2	垫圈6 GB96-85
43	H24C2-40491	Caution light	1	警示灯
44	H24C2-40431	Cable, caution light	2	警示灯线束
45	H24C2-40901	Rearview mirror	1	后视镜
46	D09JK211	Light switch	1	灯开关 JK211
47	D03RF121001	Fuel electromagnetic valve	1	燃油电磁阀 RF-12-100-1
48	B1110-06016	Screw	2	螺钉M6X16 GB67-85
49	B5050-00006	Washer, lock	2	垫圈6 GB93-87
50	B5210-00006	Washer	2	垫圈6 GB96-85
51	H99Y2-40501	Bracket	1	熄火支架
52	B1210-08010	Screw	2	螺钉M8X10 GB818-85
53	B5050-00008	Washer, lock	2	垫圈8 GB93-87
54	B5210-00008	Washer	2	垫圈8 GB96-85
55	3C53-00-09	Yoke	1	耳子
56	B3010-02020	Pin	1	开口销2X20 GB91-86
57	B5310-00006	Washer	1	垫圈6 GB97.1-85

图49/FIG49

序号 Item No	图号 Part No	零部件名称 Description	件数 Q'ty	备注 Remark
A	H2B92-40001	Electric system	1	电气系统
01	A23F2-40214	Cabinet harness	1	仪表架线束
02	H2B92-40221	Engine harness	1	发动机线束
03	H24C2-40231	Rear head guard harness	2	后护顶架线束
04	D04ZB908	Combination M/T ZB908型组合仪表总成	1	ZB908 See Fig.52
05	H24C2-40701	Rubber ring	2	防尘胶圈
06	A22A2-40800	Shuck	1	上壳
07	A22A2-40810	Shuck	1	下壳
08	A22A2-40820	Cover	1	后盖
09	Z9260-30100	Belt clip	12	捆扎带3x100
10	Z9260-40200	Belt clip	8	捆扎带4x200
11	Z9260-48350	Belt clip	2	捆扎带4.8x350
12	Z9260-80350	Belt clip	4	捆扎带8x350
13	D06BX2081	Fuse box	1	保险丝盒 BX2081
14	HRH24C2404	Rubber ring	4	出线胶圈
15	Z8510-120DZ	Back buzzer	1	倒车蜂鸣器 DJB-12B
16	B1010-06016	Screw	1	螺钉M6x16 GB65-85
17	B5050-00006	Washer,lock	1	垫圈 GB93-87
18	A91A2-40600	Cable	1	电瓶引线(+)
19	24942-42081G	Cable	1	电瓶引线(-)
20	D016-QW-80	Battery	1	蓄电池 6-QW-80
21	HAH92A2401	Cable clip	2	电瓶引线卡
22	A22A2-40900	Fusibl link wire	1	易熔线
23	Z8421-18214	Fuel level sensor	1	油量传感器
24	23652-42071G	Cable,head lamp	2	前大灯线束
25	JQK1	Relay	1	时间继电器
26	JQ1030/04	Re;ay	2	继电器 1件用于启动继电器
27	Z8500-1D124	Horn	1	喇叭DL124
28	B0110-08016	Bolt	1	螺栓M8x16 GB5781-86
29	B5050-00008	Washer,lock	1	垫圈 GB93-87

CPC,CPCD20,25,30-Ku1

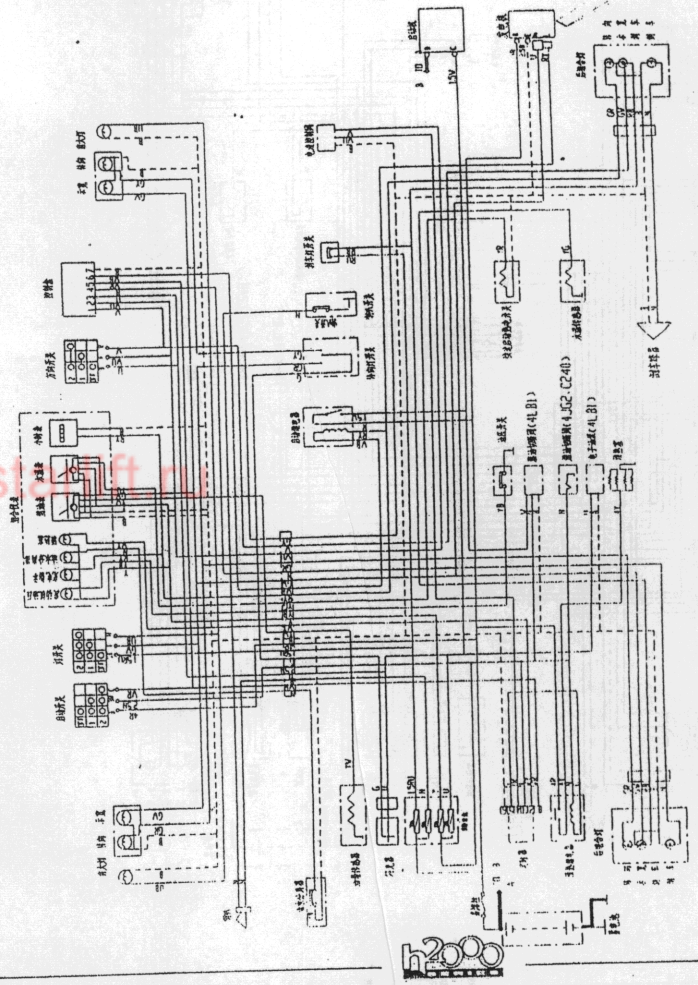
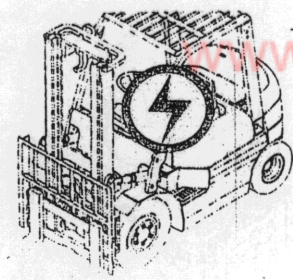

CPC, CPCD20, 25, 30-Ku1

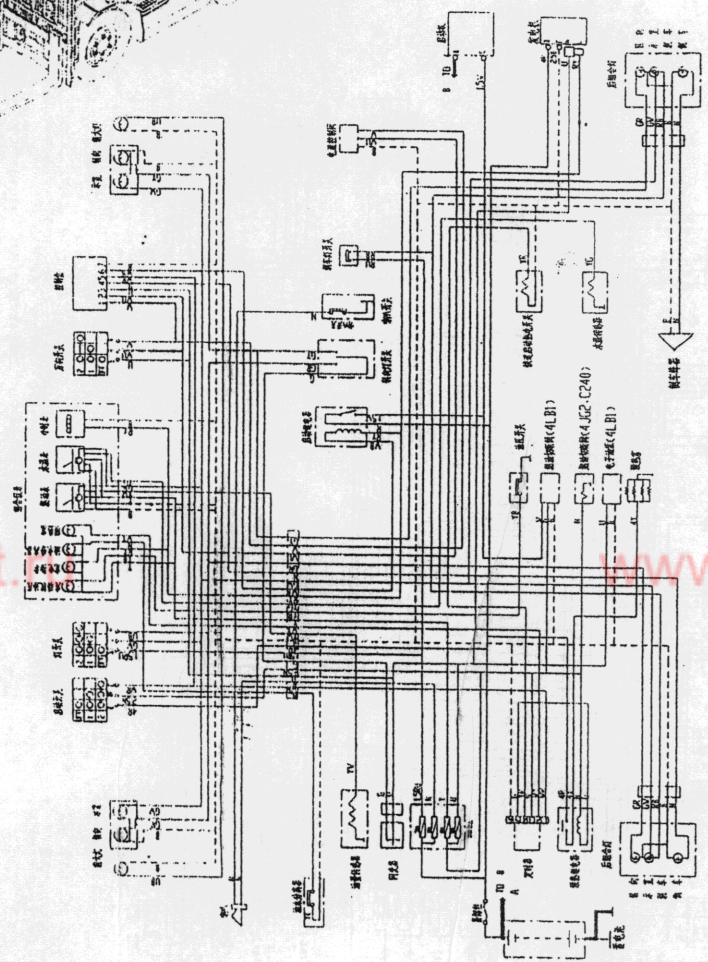
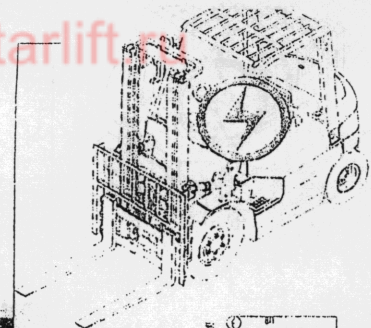

序号 Item No	图号 Part No	零部件名称 Description	件数 Q'ty	备注 Remark
30	Z8730-0802A	Switch, turn signal	1	转向灯开关 JK802A
31	Z8600-120WD	Head lamp	2	前大灯 WD115x80-FC-1L
32	Z8610-12000	Front combination lamp	2	前组合灯 XH7-1L
33	Z8620-12000	Rear combination lamp	2	后组合灯 XH8-1L
34	A22A2-42000a	Mat	2	后组合灯垫
35	Z8740-0231D	Brake switch	1	脚制动开关 JK205
36	D07SG152	Flasher unit	1	闪光器SG152 SG152
37	B1010-06010	Screw	1	螺钉M6x10 GB65-85
38	B5050-00006	Washer, lock	1	垫圈6 GB93-87
39	B5210-00006	Washer	1	垫圈6 GB96-85
40	H24C2-40491	Caution light	1	警示灯 选用
41	H24C2-40431	Wire harness, caution light	2	警示灯线束 选用
42	H24C2-40901	Backsight mirror	1	后视镜 选用
43	D09JK211	Light switch	1	灯开关 JK211

B

序号 Item No	图号 Part No	零部件名称 Description	件数 Q'ty	备注 Remark
A	Z8498-ZB103	Combination M/T H2000型组合仪表总成	1	除CPC(D)20-35-HJ 外柴油车
	Z8498-ZB103S	Combination M/T H2000型组合仪表总成	1	CPQ,CPQD20-35
	P62B2-40201	Combination M/T H2000型组合仪表总成	1	CPC(D)20-35-HJ
01	XL8.840.001	Cover 面罩	1	
02	XL8.846.001	Shuck 外壳	1	
03	XL5.944.003	Stopwatch 小时表	1	
04	XL8.803.001	Front-panel 面板	1	
05	XL5.944.002	Indicator, temperature 水温表指示器	1	除CPC(D)20-35-HJ 外柴油车
	XL5.944.020	Indicator, temperature 水温表指示器	1	CPQ,CPQD20-35
	XL5.944.021	Indicator, temperature 水温表指示器	1	CPC(D)20-35-HJ
06	XL5.944.001	Indicator, fuel 燃油表指示器	1	
07	XL8.088.003	Circuit board 线路板	1	
08	PL1.2	Bulb 灯泡	8	
09	DJ7082-6.3-11	Jacket, 8-wire plug 八线插头护套	1	
10	DJ7062-6.3-11	Jacket, 6-wire plug 六线插头护套	1	

CPQ,CPQD20,25,30,35
CPC,CPCD20,25,30,35

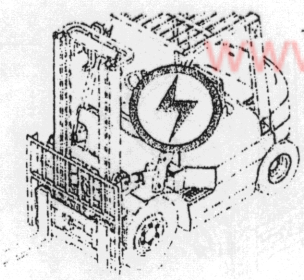

B

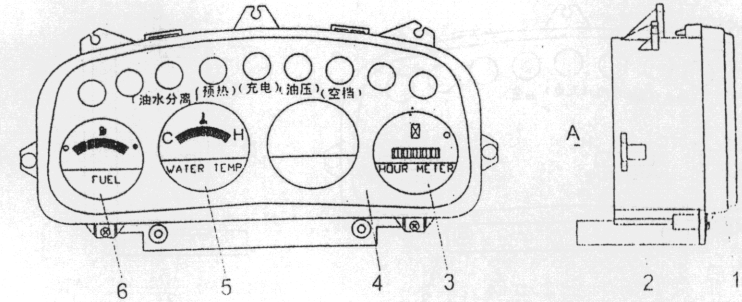

A向

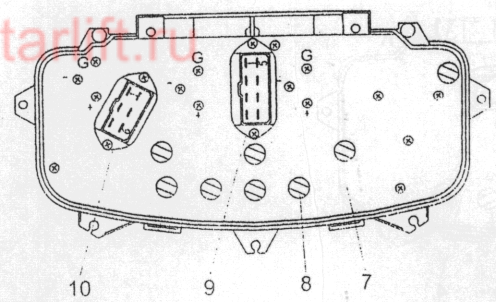

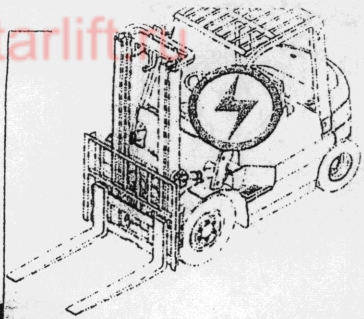

CPQ, CPQD20, 25, 30, 35
CPC, CPCD20, 25, 30, 35

序号 Item No	图号 Part No	零部件名称 Description	件数 Q'ty	备注 Remark
A	H24C2-40511	Combination M/T H2001型组合仪表	1	除日产汽油机用
-	H24C2-40521	Combination M/T H2001型组合仪表	11	仅日产汽油机用
01	H2001-20	Cover	面罩	1
02	H2001-10	Shuck	外壳	1
03	H2001-11	Front-panel	面板	1
04	H2001-13/ H2001.PCB	Circuit board & meter core 线路板与表芯总成	1	除日产汽油机用
-	H2001-13/ H2001.PCB	Circuit board & meter core 线路板与表芯总成	1	仅日产汽油机用
05	PL1.2	Bulb	灯泡	4
06	DJ7082-6.3-11	Jacket, 8-wire plug	八线插头护套	1
07	DJ7062-6.3-11	Jacket, 6-wire plug	六线插头护套	1

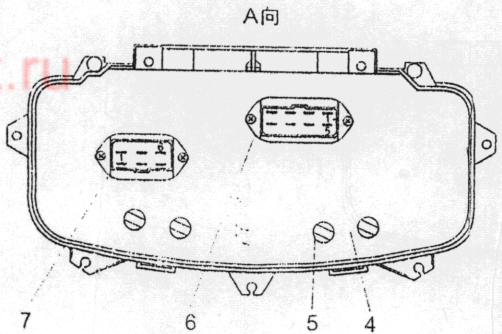
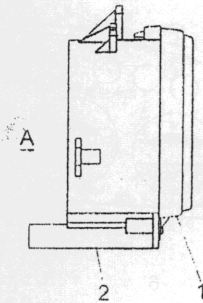
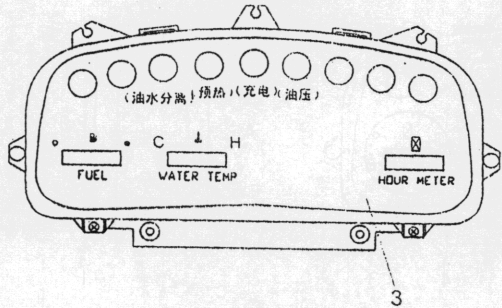

序号 Item No.	图号 Part No.	零部件名称 Description	件数 Q'ty	备注 Remark
A	D04ZB908GZ	Combination M/T	1	CPC(D)20-35-ZJ3
	D04ZB908JH	Combination M/T	1	XL3.926.030 CPC(D)20-35-HJ,D CPQ(D)20-35-ZJ2
	D04ZB908	Combination M/T	1	CPC(D)20-30-Ku1
01	XL8.804.057	Temperature meter	1	
02	XL7.824.037	Circuit board & meter core	1	除CPC(D)20-30-Ku1外
	XL7.824.035	Circuit board & meter core	1	CPC(D)20-30-Ku1
03	XL8.804.058	Fuel meter	1	
04	XL8.840.001	Cover	1	
05	XL8.846.001	Shunk	1	
06	XL8.846.030	Rear cover	1	
07	XL8.804.060	Type sign	1	
08	DJ7161-2.3-20	16-wire socket	1	
09	XL8.804.059	Lamp	1	CPC(D)20-35-ZJ3

CPC, CPCD20, 25, 30, 35-HJ, D, Ku1
CPQ, CPQD20, 25, 30, 35-ZJ2, ZJ3

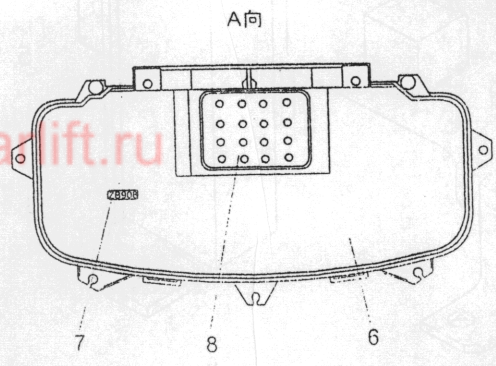
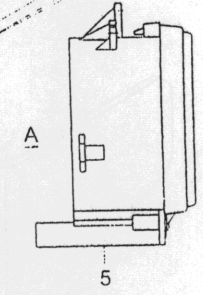
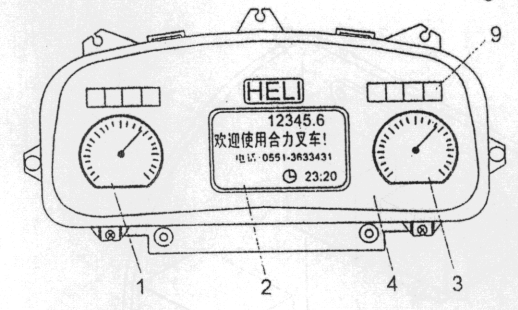
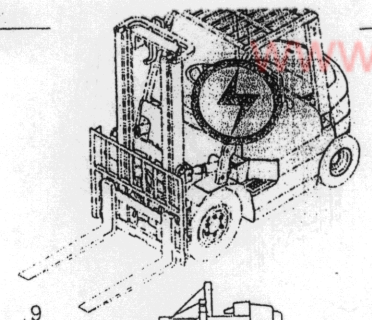

B



CPC,CPCD20,25,30-KU1

序号 Item No	图号 Part No	零部件名称 Description	件数 Q'ty	备注 Remark
01	JQK1	Relay	1	时间继电器
02	D07SG152	Flasher unit	1	闪光器SG152
03	D06BX2081	Fuse box	1	保险丝盒
04	JQ1030/04	Warm-up relay	1	继电器
05	JQ1030/04	Start-up relay	1	继电器 用于启动继电器
06	H2B16-41201	Board,electric element		电气板总成

B

